

54

Tracheotomie, Kropf  
Tracheostomy, Goitre  
Trachéotomie, Goitre  
Traqueotomía, Bocio  
Tracheotomia, Gozzo

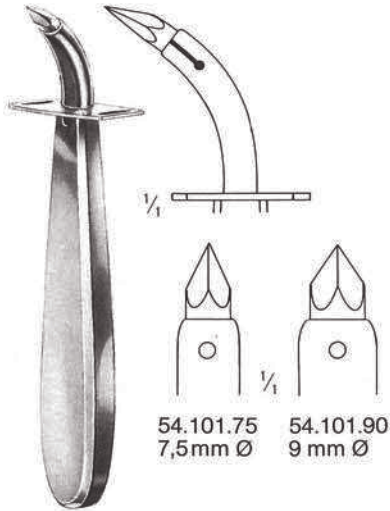

**UCKERMANN**  
 54.101.75-54.101.90  
 13 cm

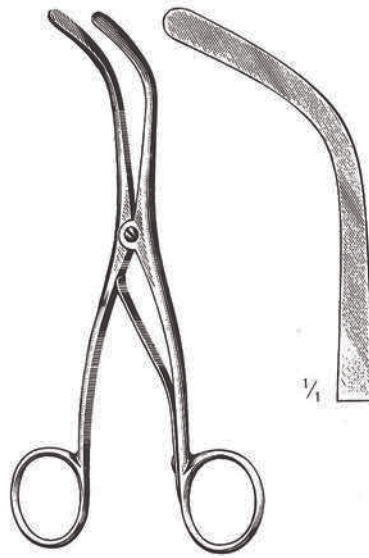

**TROUSSEAU**  
 54.111.14  
 14 cm

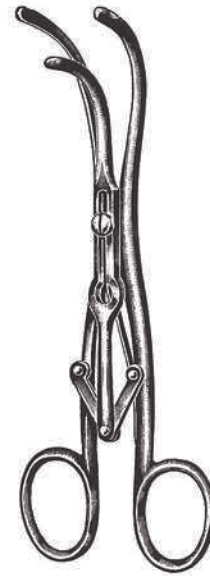

**LABORDE**  
 54.113.14  
 14 cm



**BOSE**  
 54.115.07  
 7 cm



**JACKSON**  
 54.116.15  
 15 cm

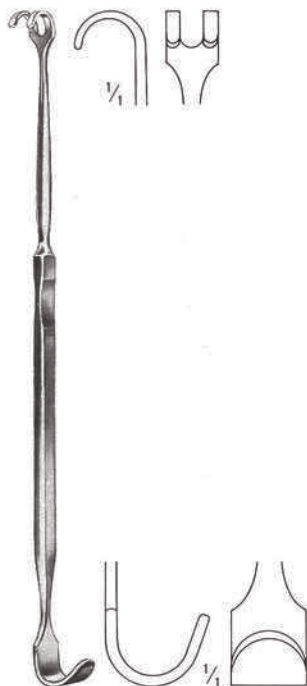

**JACKSON**  
 54.117.17  
 17 cm

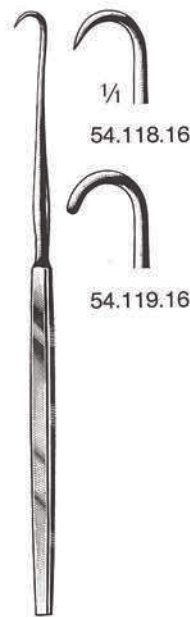

**ITERSON**  
 54.118.16-54.119.16  
 16 cm

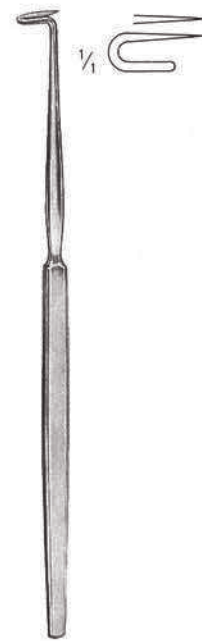

**BOSE**  
 54.122.16  
 16 cm



**BOSE**  
 54.124.16  
 16 cm

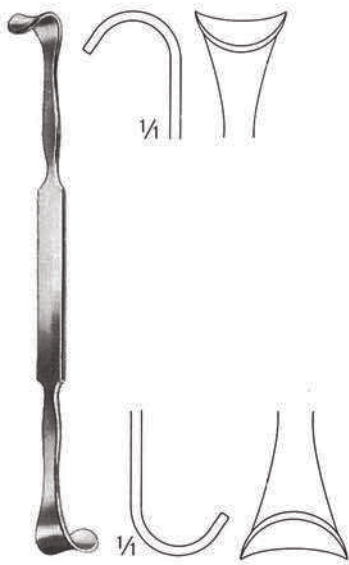

ROSE  
54.130.13  
13 cm



mm	WAGENER-MOSHER
5	54.151.05
7	54.151.07
9	54.151.09

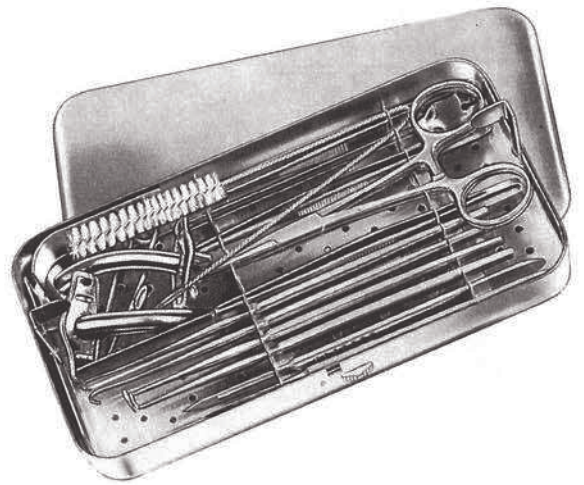

54.270.00

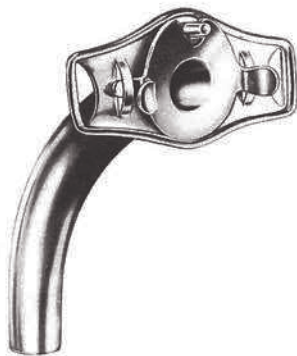

Fig.	mm	LUER
0	4	54.220.04
1	5	54.220.05
2	6	54.220.06
3	7	54.220.07
4	8	54.220.08
5	9	54.220.09
6	10	54.220.10
7	11	54.220.11
8	12	54.220.12
9	13	54.220.13

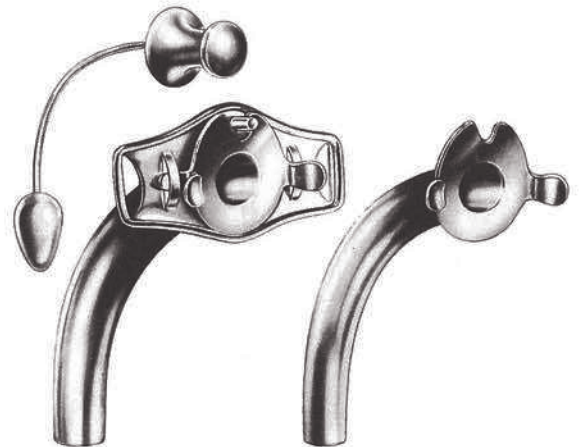
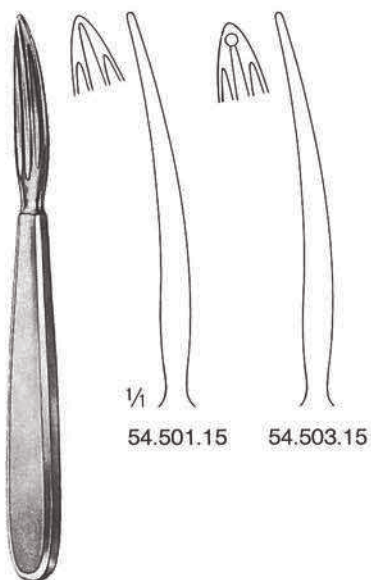

Fig.	mm	JACKSON
0	4	54.240.04
1	5	54.240.05
2	6	54.240.06
3	7	54.240.07
4	8	54.240.08
5	9	54.240.09
6	10	54.240.10
7	11	54.240.11
8	12	54.240.12
9	13	54.240.13



KOCHER  
54.501.15-54.503.15  
15 cm



SCHOENBORN  
54.511.21  
21 cm



cm	LAHEY
15	54.520.15
20	54.520.20

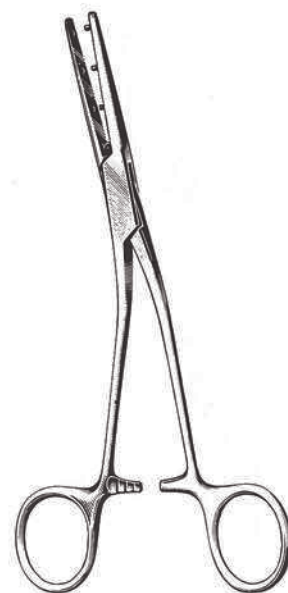

MASTIN  
54.523.17  
17 cm