

46

Rhinologie
Rhinology
Rhinologie
Rinología
Rinologia

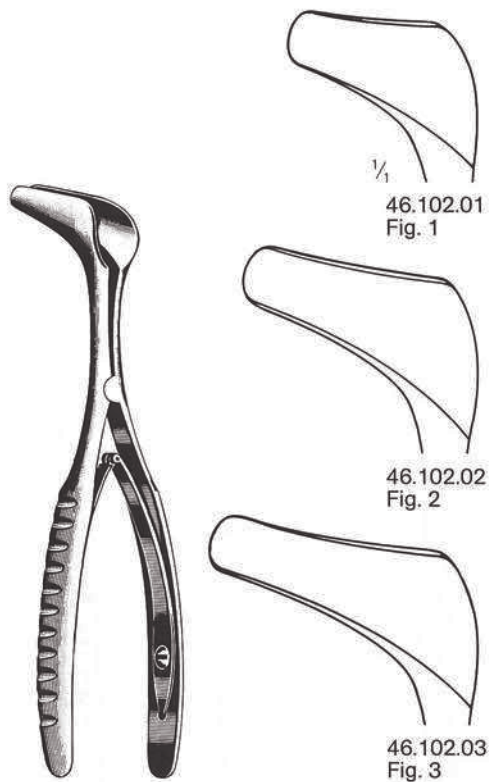

HARTMANN-HALLE
 46.102.01-46.102.03
 15 cm

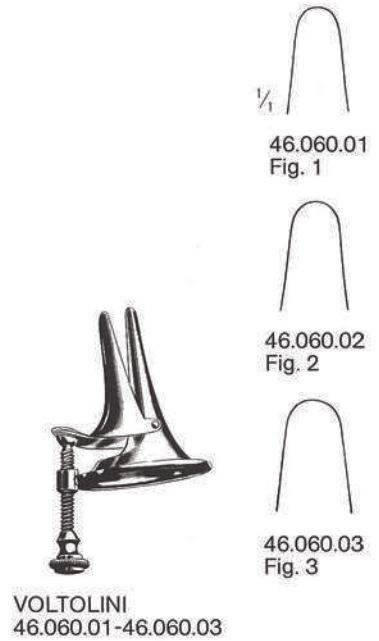
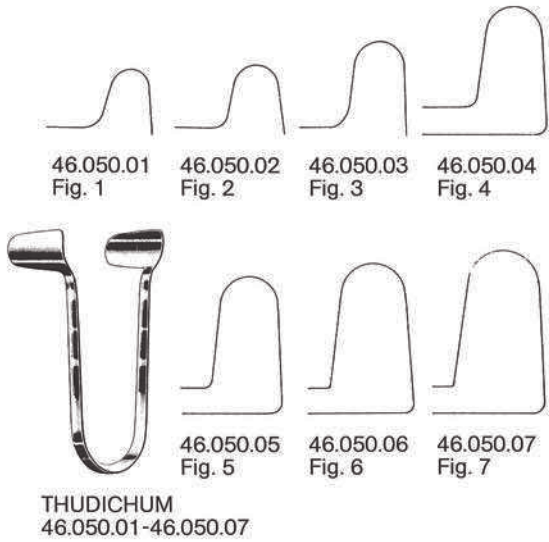

Mod. Wien · Vienna ·
 Vienne · Viena

Baby · Bébé	46.112.01
Kind · child · enf. · niño · bamb.	46.112.02
Erw. · Adult.	46.112.03



Mod. Wien · Vienna
 Vienne · Viena
 46.113.03
 leichtes Modell
 lightweight
 mod. léger
 mod. ligero
 mod. leggero

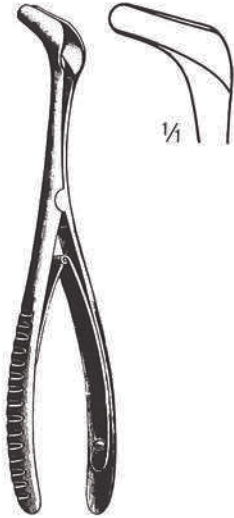

TIECK-HALLE
 46.116.13
 13,5 cm



KILLIAN
 46.120.35-46.120.90
 13 cm

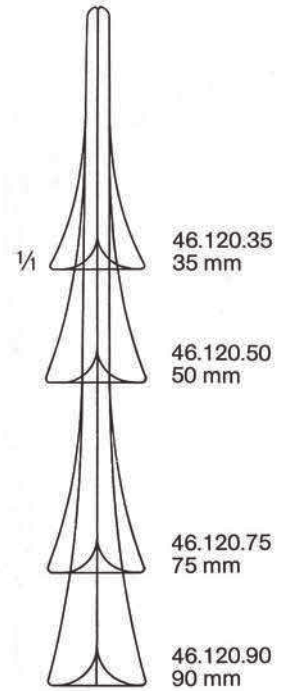

COTTLE
 46.124.35-46.124.90
 14 cm

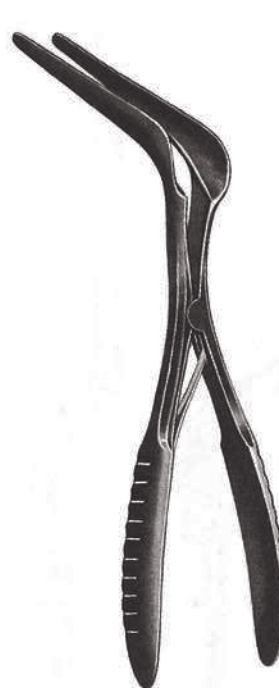

COTTLE
 46.126.35-46.126.90
 schwarz · black · noirs
 negros · neri
 14 cm

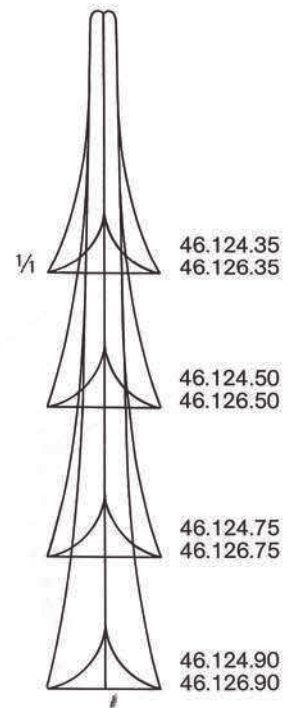



YANKAUER
 46.131.19
 19 cm

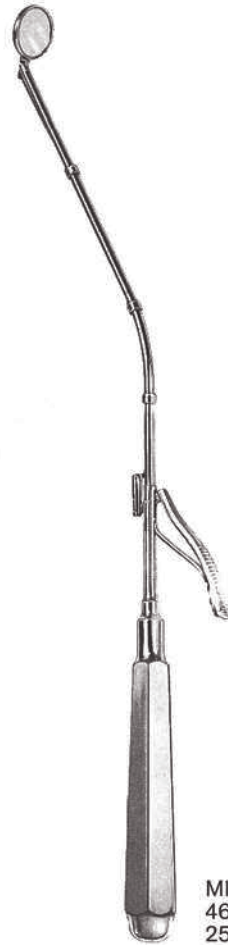

MICHEL
 46.139.12-46.139.18
 25 cm

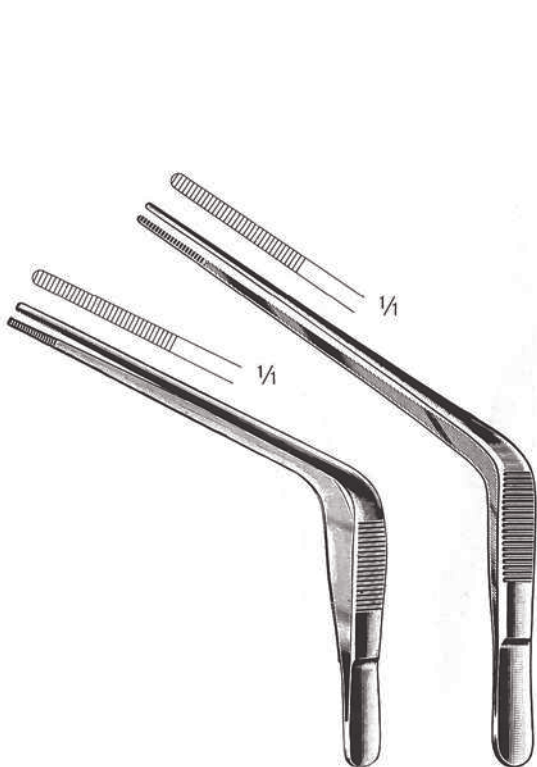
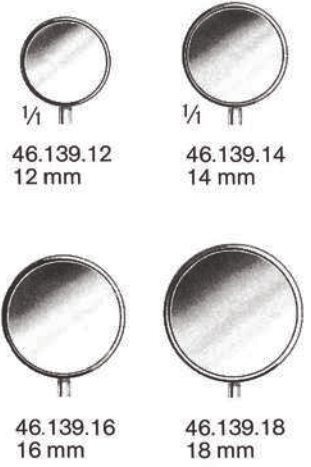

TROELTSCH
 46.151.15
 15 cm

TROELTSCH
 46.151.18
 18 cm



JANSEN
 46.154.20
 20 cm

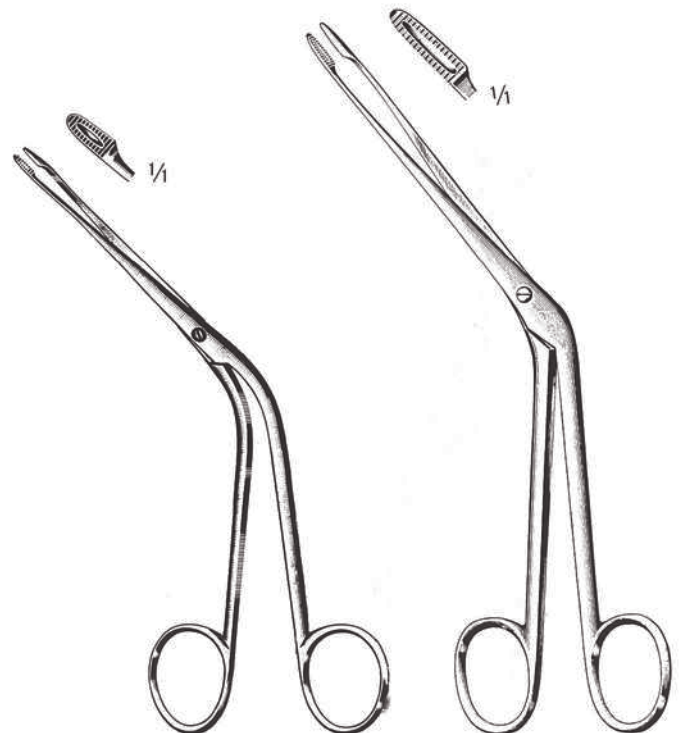

HARTMANN
 46.161.16
 16 cm

HARTMANN
 46.161.20
 20 cm

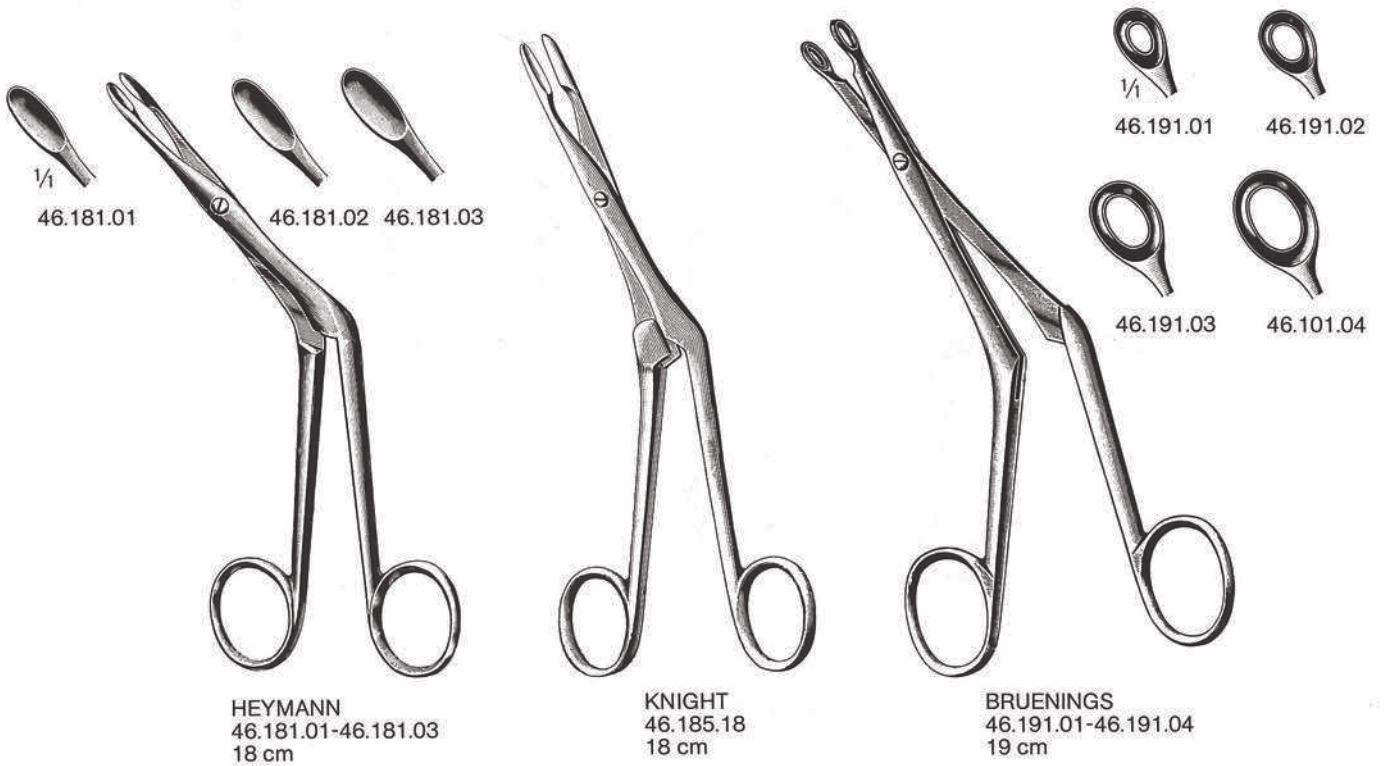
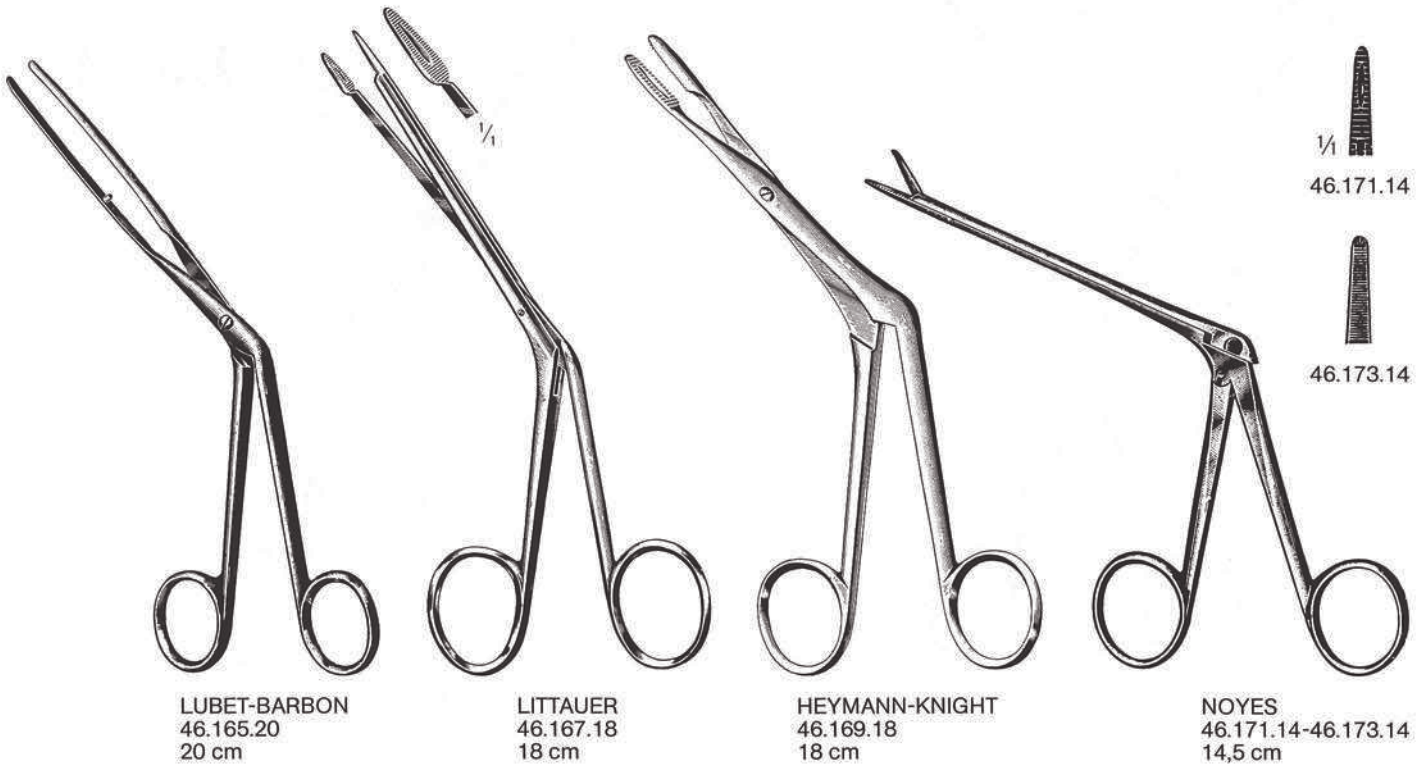

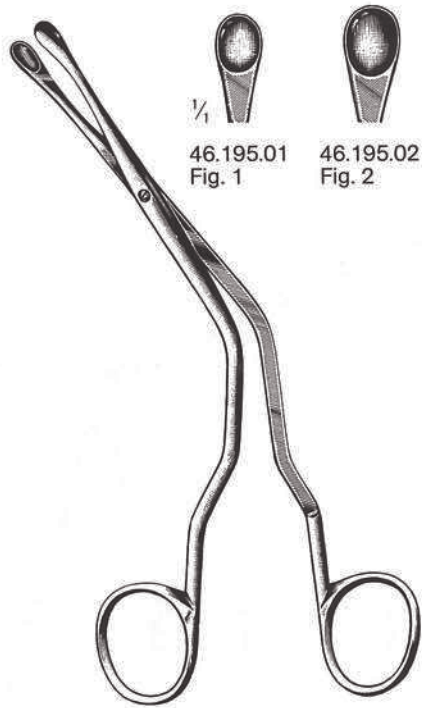

1/4
 46.195.01 Fig. 1
 46.195.02 Fig. 2

LUC
 46.195.01-46.195.02
 19 cm

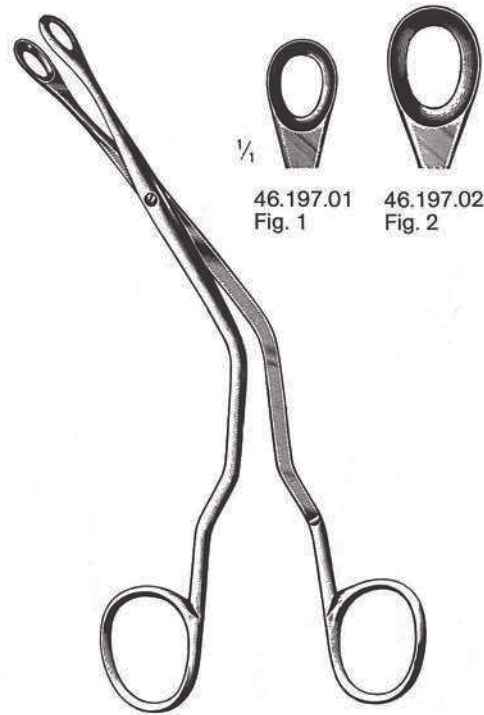

1/4
 46.197.01 Fig. 1
 46.197.02 Fig. 2

LUC
 46.197.01-46.197.02
 19 cm

ohne Hals
 without neck
 sans cou
 sin cuello
 senza collo



1/4
 46.221.01 Fig. 1

1/4
 46.221.02 Fig. 2

1/4
 46.221.03 Fig. 3

1/4
 46.221.04 Fig. 4

1/4
 46.221.05 Fig. 5

mit Hals
 with neck
 avec cou
 con cuello
 con collo



1/4
 46.223.01 Fig. 1

1/4
 46.223.02 Fig. 2

1/4
 46.223.03 Fig. 3

1/4
 46.223.04 Fig. 4

1/4
 46.223.05 Fig. 5

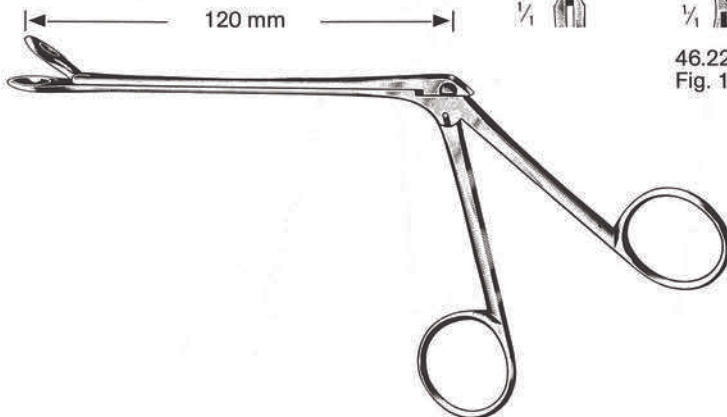

WEIL-BLAKESLEY
 46.221.01-46.223.05

Scharfe Nasenzangen
 Nasal Cutting Forceps
 Pinces coupantes nasales
 Pinzas cortantes nasales
 Pinze taglianti nasali

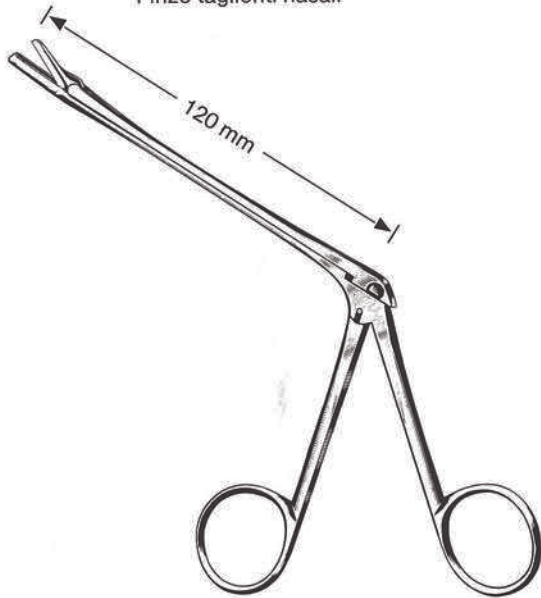

46.231.01-46.237.03
 19 cm



STRUYCKEN
 46.231.01
 Fig. 1



STRUYCKEN
 46.231.02
 Fig. 2

- 46.237.01
5 mm
- 46.237.02
7 mm
- 46.237.03
9 mm

- 46.235.05
- 46.235.07
- 46.235.09
- 46.235.11



MYLES



HARTMANN

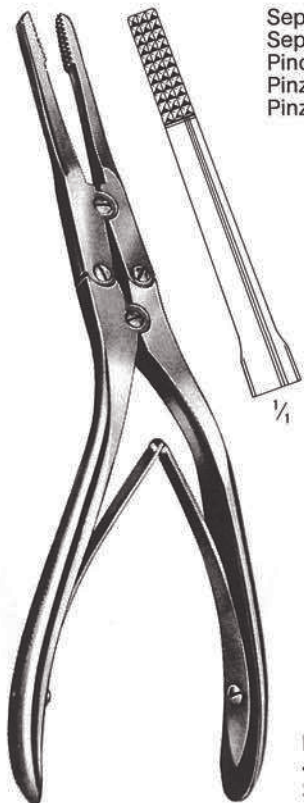

Septum-Quetschzange
 Septum Crushing Forceps
 Pince à écraser la cloison
 Pinza para magullar tabique
 Pinza per ammaccare il setto

RUBIN
 46.251.21
 21 cm



mm x mm	KERRISON
3 x 3	46.303.03
4 x 4	46.303.04
5 x 5	46.303.05
6 x 6	46.303.06
17 cm	

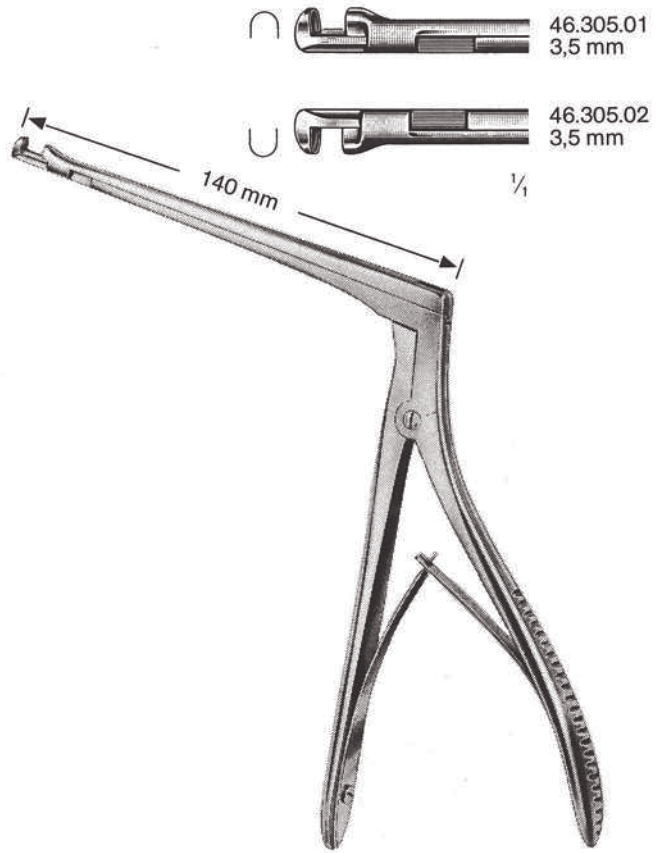

HAJEK-KOFLER
 46.305.01-46.305.02



mm	CITELLI
1,0	46.311.10
2,5	46.311.25
4,0	46.311.40



BEYER
 46.315.20
 2,0 mm

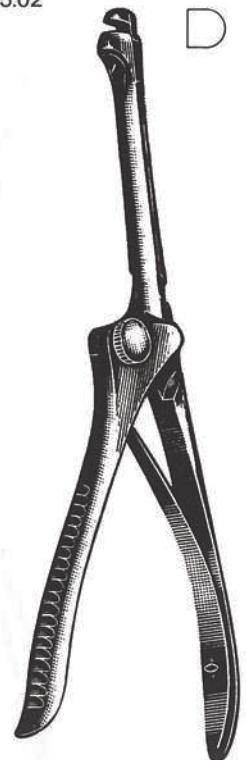

HAJEK-CLAUS
 46.320.20
 20 cm

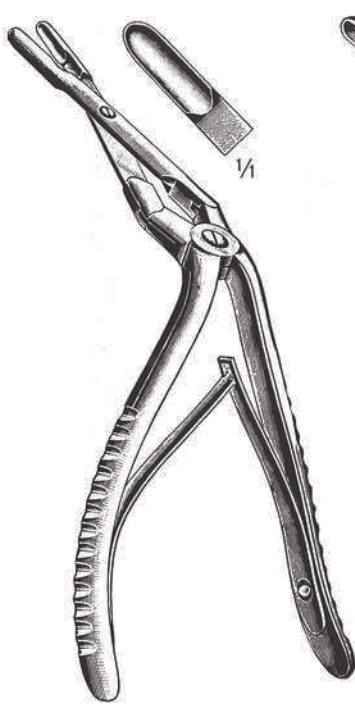

MIDDLETON-JANSEN
 46.323.19
 19 cm



MIDDLETON-JANSEN
 46.325.19
 19 cm



Ø mm	LICHTWITZ
1,5	46.340.15
1,8	46.340.18
2,0	46.340.20

Luer-Lock
 10 cm



KILLIAN
 46.341.03
 14 cm/3 mm Ø



KRAUSE
 46.351.26
 26 cm



WILDE
 46.352.24
 24 cm



46.355.03
 0,3 mm



JOSEPH
 46.370.16-46.373.16



46.370.16
 stumpf · blunt · mouses
 romos · smussi



46.371.16



46.372.16
 spitz · pointed · pointus
 puntiagudos · acuti



46.373.16



FREER
 46.374.15
 15 cm



FREER
 46.375.19
 19 cm



JOSEPH
 46.376.16
 16 cm



1/4

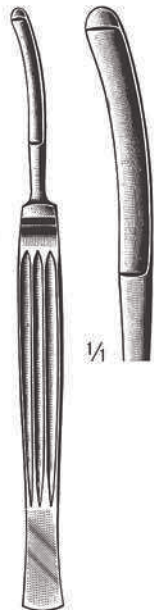

CONVERSE
 46.379.16
 16 cm



1/4



COTTLE
 46.380.15
 15 cm



46.382.15



COTTLE
 46.384.15



46.385.15

Septum-Messer
 Septum Knives
 Couteaux pour la cloison
 Cuchillos para tabique
 Coltelli per setto

dimed[®]

SURGICAL INSTRUMENTS

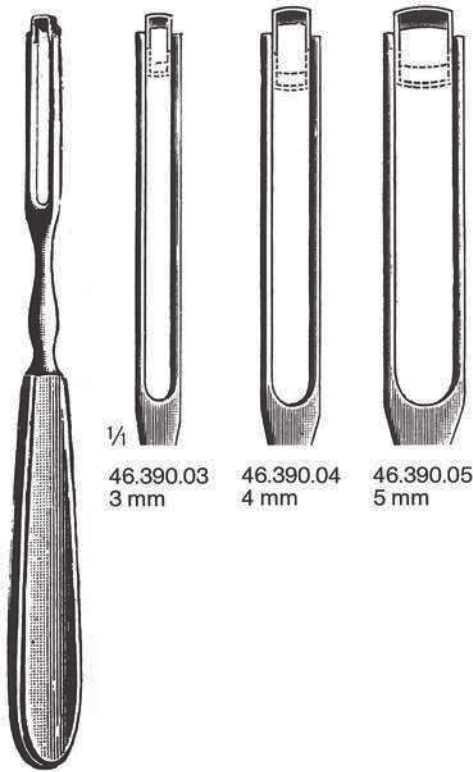

1/4
 46.390.03 3 mm
 46.390.04 4 mm
 46.390.05 5 mm

BALLENGER
 46.390.03-46.392.05
 20 cm

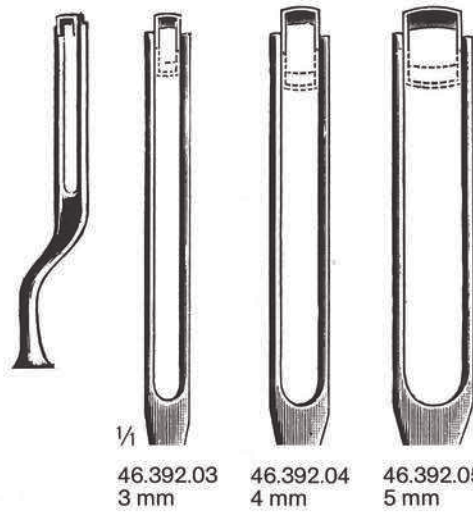

1/4
 46.392.03 3 mm
 46.392.04 4 mm
 46.392.05 5 mm

Septum-Elevatorien
 Septum Elevators
 Élévateurs pour la cloison nasale
 Elevadores para tabique
 Elevatori per setto



BRUENINGS
 46.398.16
 16,5 cm

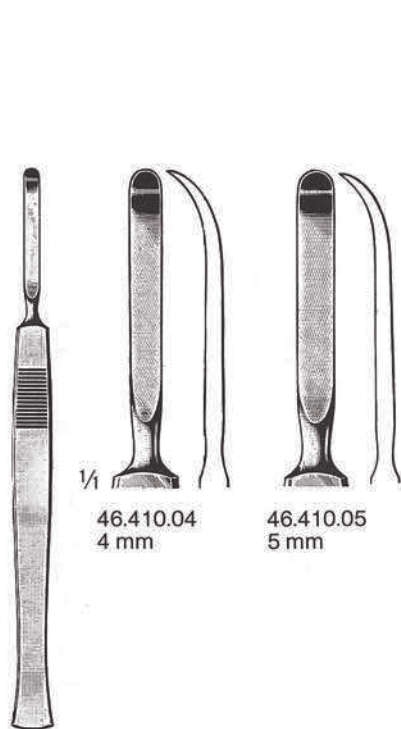

1/4
 46.410.04 4 mm
 46.410.05 5 mm

McKENTY
 46.410.04-46.410.05
 15 cm

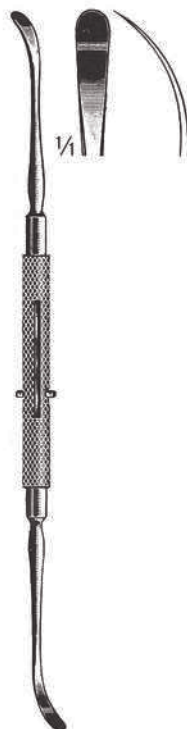

ROGER
 46.413.19
 19 cm



FREER
 46.415.18
 18 cm



FREER
 46.417.19
 19 cm



FREER
 46.419.19
 19 cm

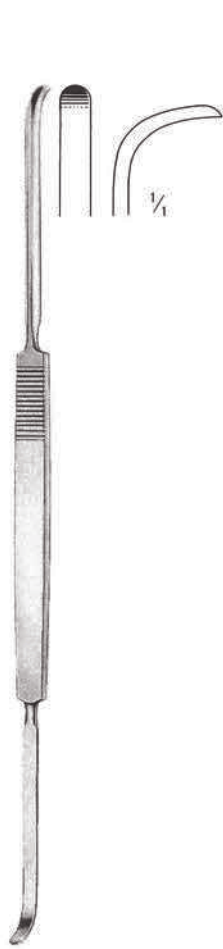

COTTLE
 46.421.23
 23 cm



COTTLE
 46.423.22
 22 cm



JOSEPH
 46.425.16
 16 cm



COTTLE
 46.425.19
 19 cm



KILLIAN
 46.426.22
 22 cm



HAJEK-BALLENGER
 46.428.21
 22 cm



BALLENGER
 46.430.22
 22 cm



FREER
 46.450.04
 4 mm



FREER
 46.451.04
 4 mm

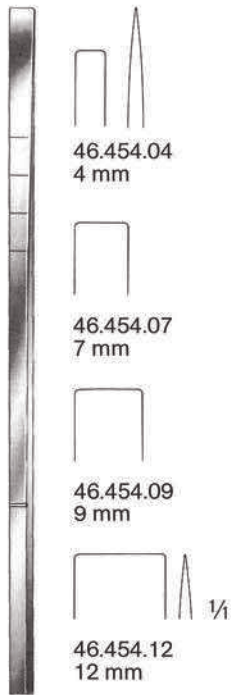

COTTLE
 46.454.04-46.454.12
 18 cm

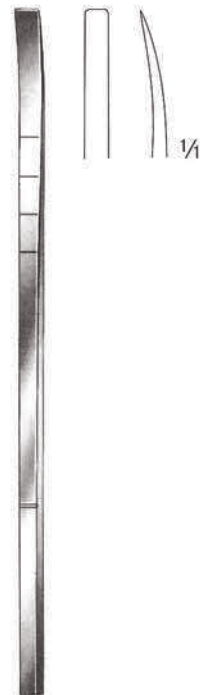

COTTLE
 46.455.06
 18 cm/6 mm

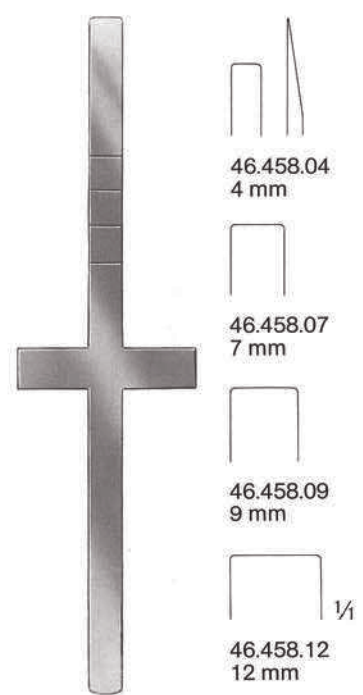

COTTLE
 46.458.04-46.458.12

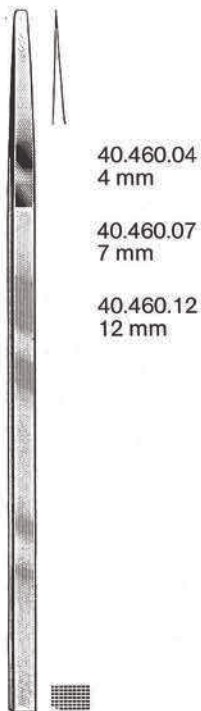

COTTLE
 40.460.04-40.460.12
 18 cm

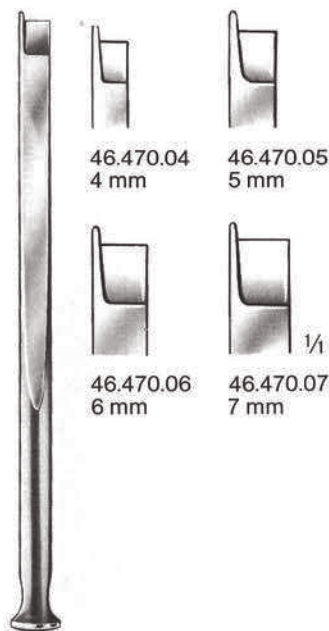

FOMON
 46.470.04-46.470.07
 17 cm

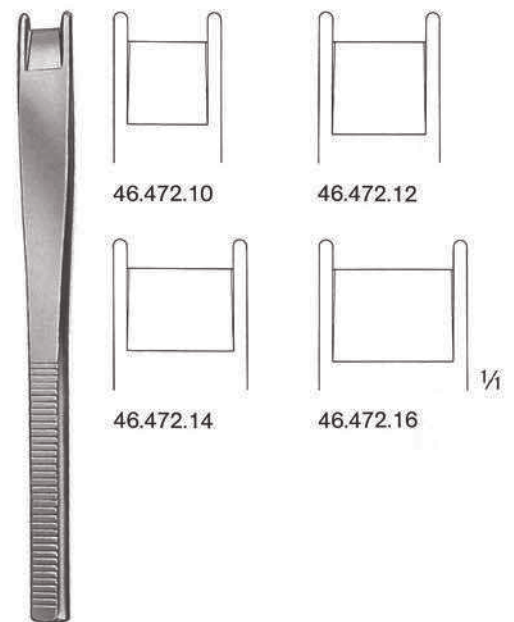

CINELLI
 46.472.10-46.472.16

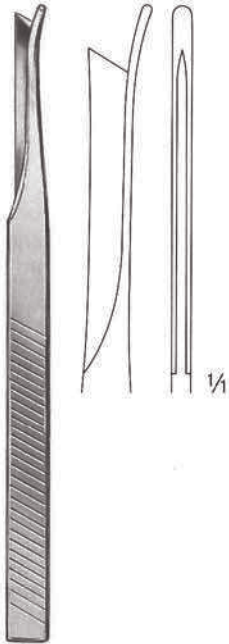

SILVER
 46.473.01
 18 cm

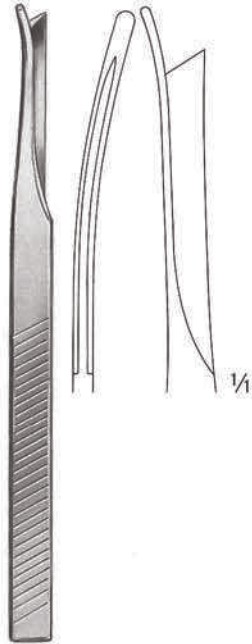

SILVER
 46.473.02
 18 cm

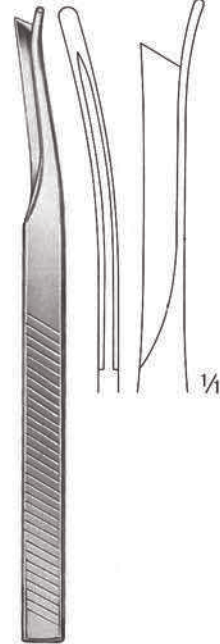

SILVER
 46.473.03
 18 cm

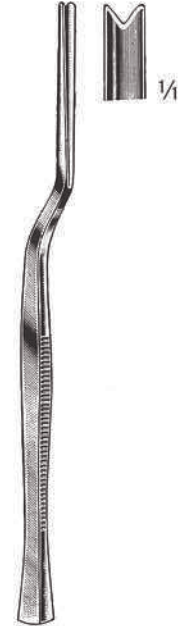

KILLIAN-CLAUS
 46.482.05
 17 cm/5 mm



mm	HAJEK
4	46.484.04
6	46.484.06
8	46.484.08



WEST
 46.486.16
 16 cm



WEST
 46.487.16
 16 cm



FREER
 46.489.16
 6 mm

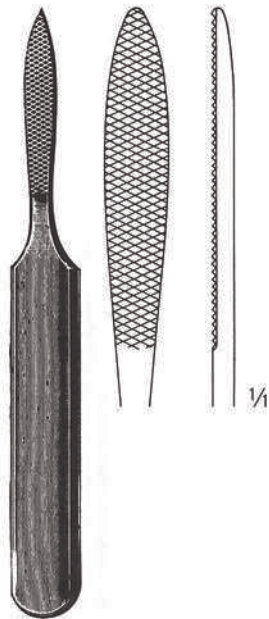

JOSEPH
 46.502.16
 16 cm

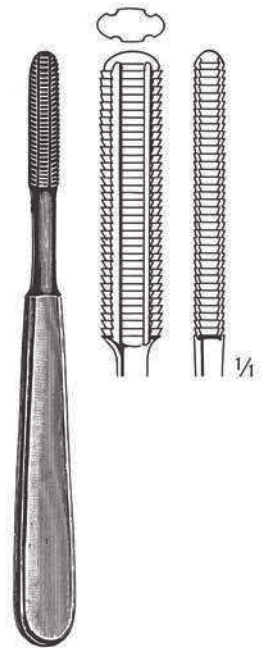

AUFRICHT
 46.504.18
 18 cm

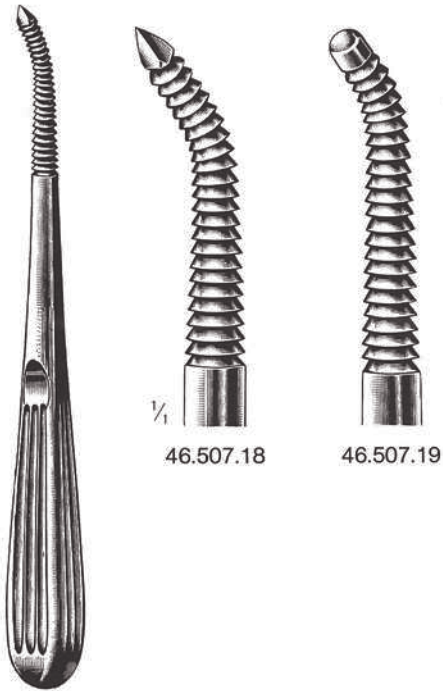

WIENER
 46.507.18-46.507.19
 18 cm

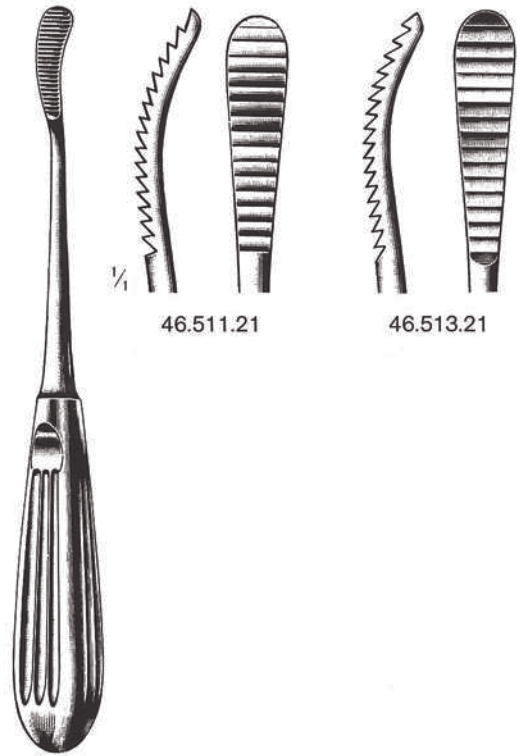

WIENER (AUFRICHT)
 46.511.21-46.513.21
 21 cm

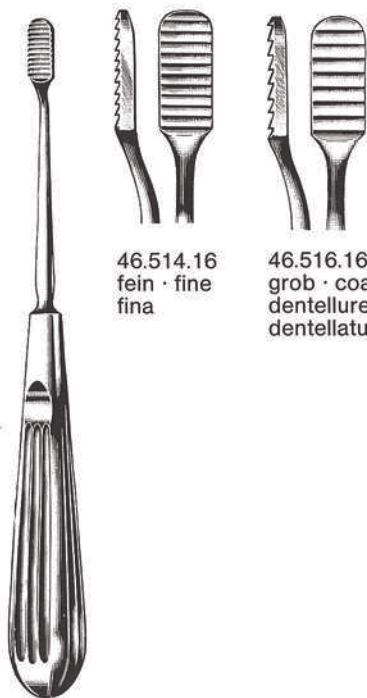

46.514.16
 fein · fine
 fina

46.516.16
 grob · coarse · gruesa
 dentellure grosse
 dentellatura grossa

JOSEPH (LEWIS)
 46.514.16-46.516.16
 18 cm

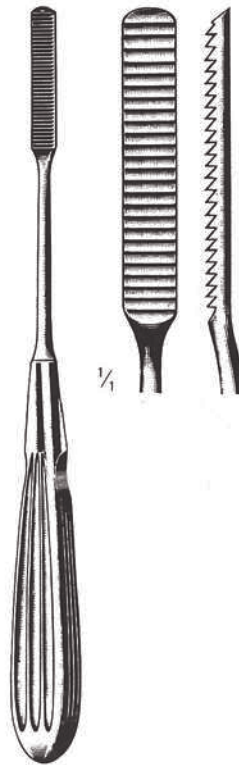

MALTZ (COTTLE)
 46.518.21
 21 cm

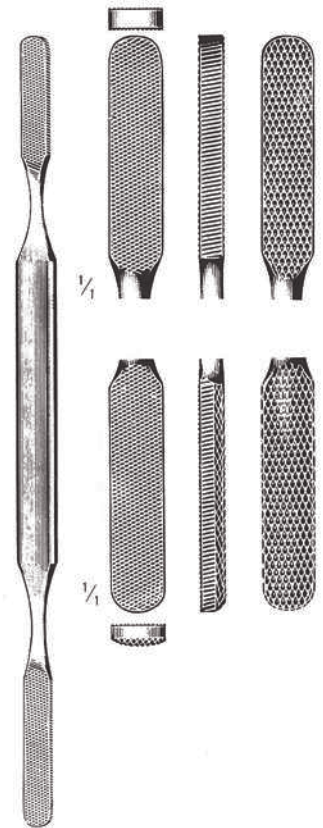

FOMON
 46.520.21
 21 cm

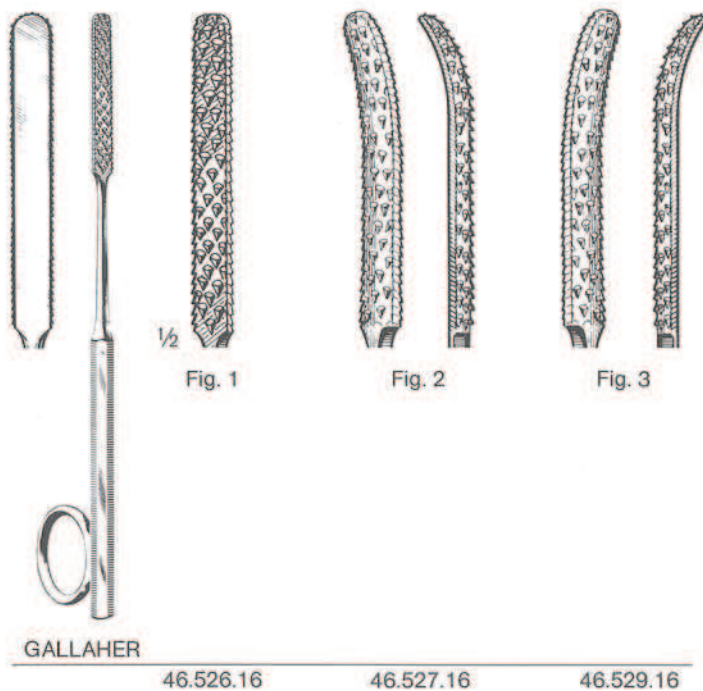
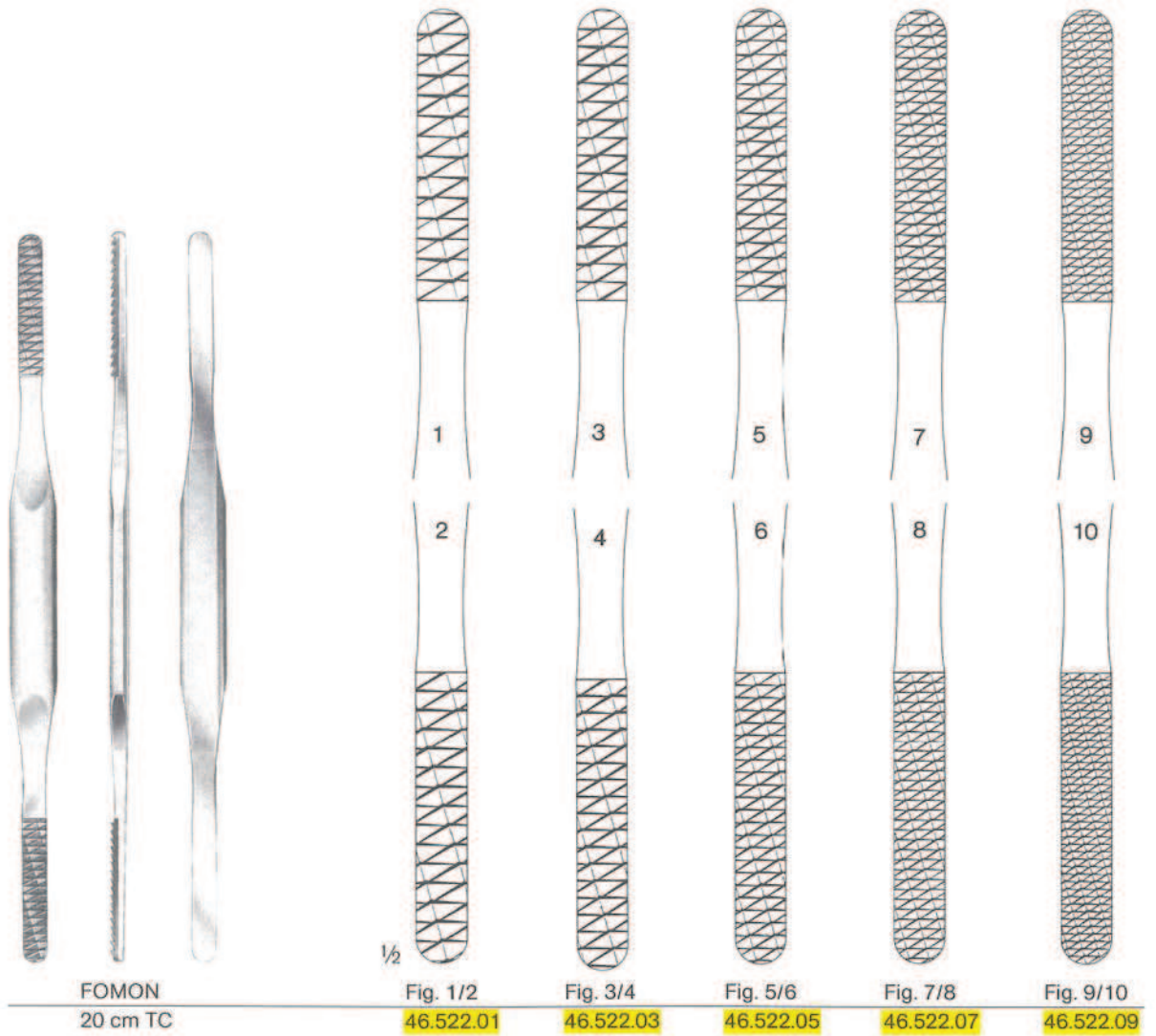



JOSEPH

19 cm	46.532.19	46.534.19
	links · left ·	rechts · right ·
	à gauche	à droite
	izquierda	derecha
	a sinistra	a destra

JOSEPH
 46.535.01 17 cm 46.535.02

AUFRICHT
 46.551.16
 19 cm

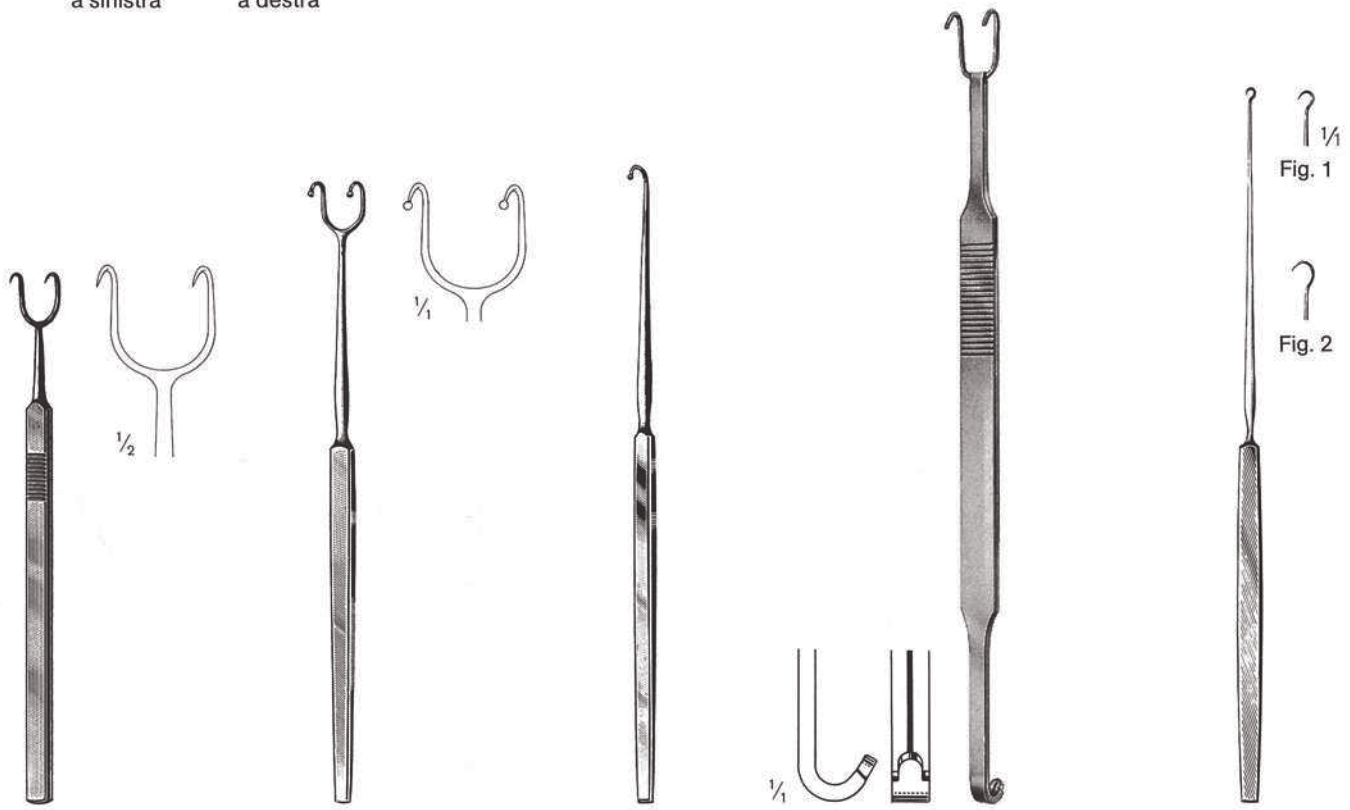

COTTLE
 46.556.14

FOMON
 46.556.16

FOMON
 46.557.17

COTTLE-NEIVERT
 46.559.20

Fig.	GILLIES
1	46.560.18
2	46.562.18
	18 cm

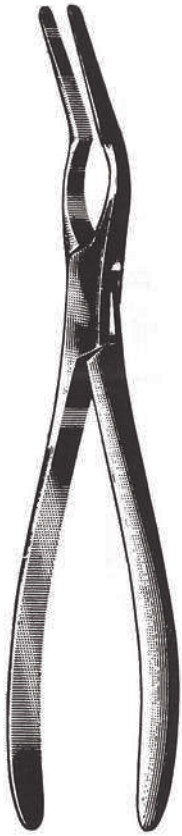

ASCH
 46.571.23
 23 cm

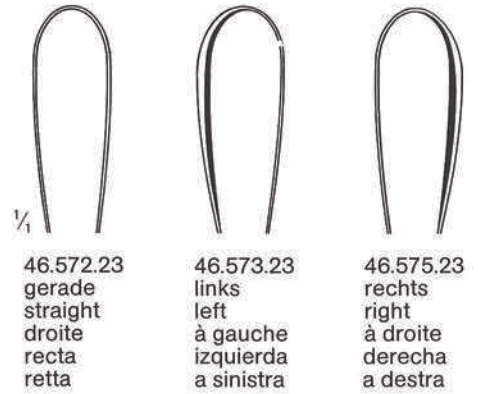
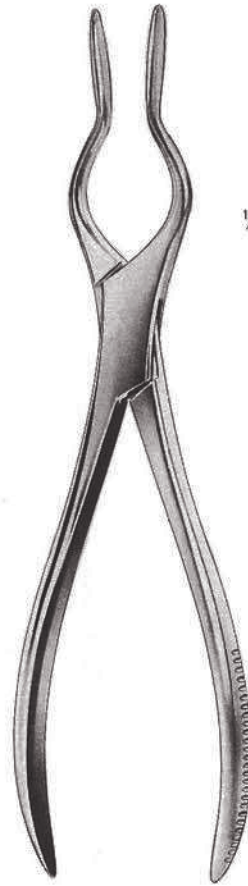

46.572.23
 gerade
 straight
 droite
 recta
 retta

46.573.23
 links
 left
 à gauche
 izquierda
 a sinistra

46.575.23
 rechts
 right
 à droite
 derecha
 a destra

WALSHAM
 46.572.23-46.575.23
 23 cm



JATHO
 46.595.15



FAULKNER
 46.601.21
 21 cm

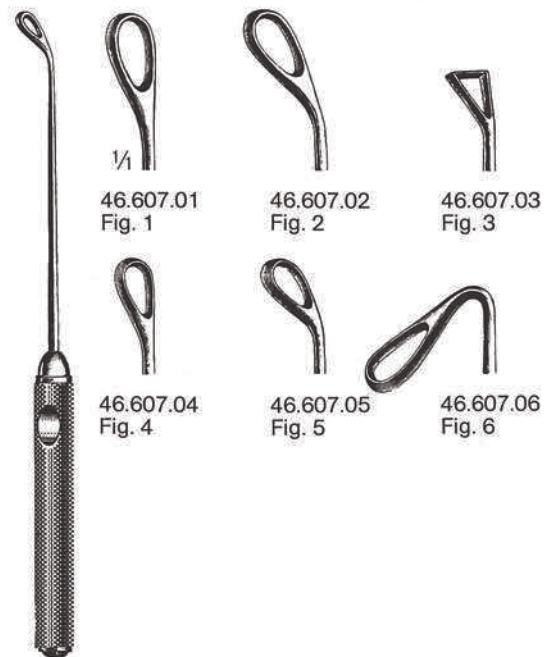

COAKLEY
 46.607.01-46.607.06
 17 cm

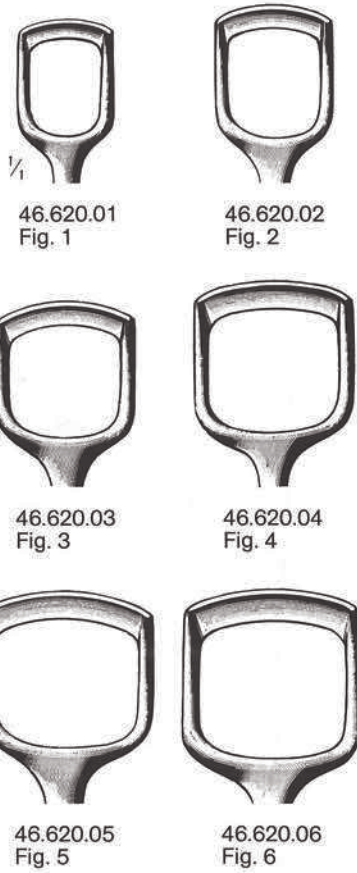

BECKMANN
 46.620.01-46.620.06
 22 cm

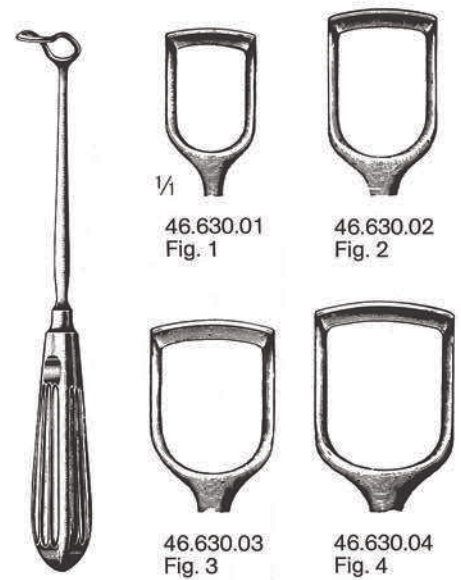

BARNHILL
 46.630.01-46.630.04
 21 cm

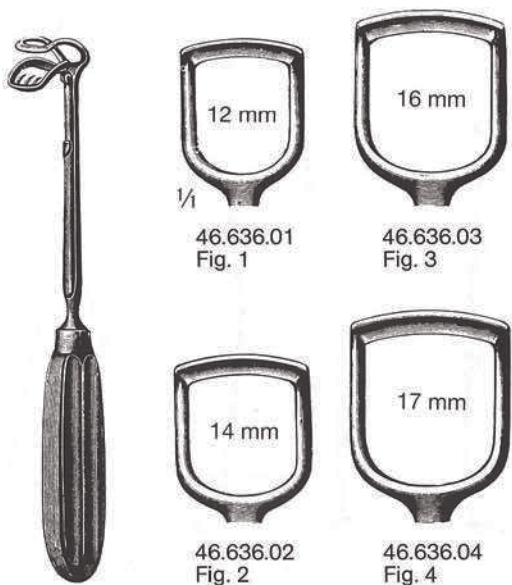

St. CLAIR-THOMSON
 46.636.01-46.636.04
 21 cm

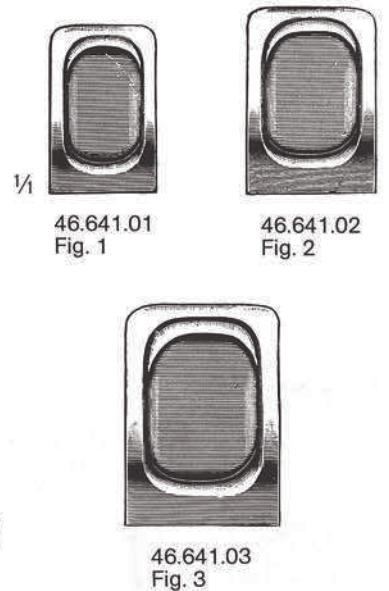

LAFORCE
 46.641.01-46.641.03
 25 cm

Ersatzklingen, gelocht
 Spare blades, perforated
 Lames de rechange, perforées
 Hojas de repuesto, perforadas
 Lame di ricambio, forate

Fig.	
1	46.642.01
2	46.642.02
3	46.642.03

dimeda[®]

SURGICAL INSTRUMENTS