

13

Atraumatische Klemmen

Atraumatic Forceps

Pinces atraumatique

Pinzas atraumatico

Pinze atraumatico



cm — HALSTEAD-MOSQUITO —  
 12,0 13.080.12 13.081.12  
 15,0 13.080.15 13.081.15

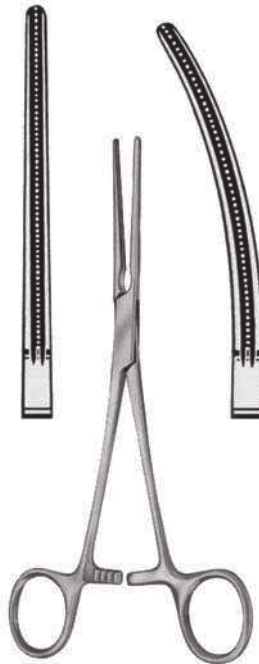

cm — PEAN —  
 14,0 13.082.14 13.083.14  
 16,0 13.082.16 13.083.16  
 18,0 13.082.18 13.083.18  
 20,0 13.082.20 13.083.20

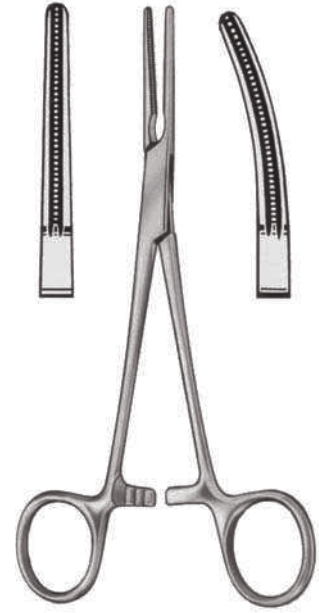

cm — RANKIN —  
 16,0 13.084.16  
 13.085.16

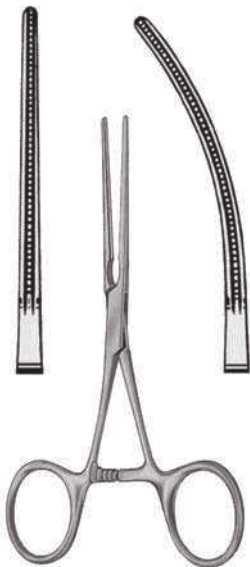

cm — DE BAKEY —  
 12,0 13.102.12 13.103.12

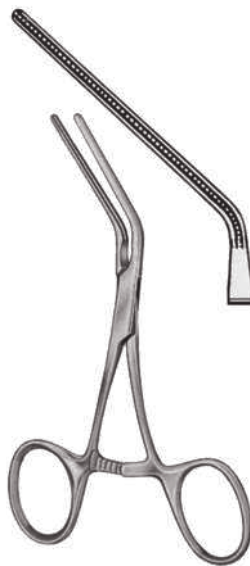

DE BAKEY  
 13.111.12  
 12,0 cm



DE BAKEY  
 13.113.12  
 12,0 cm

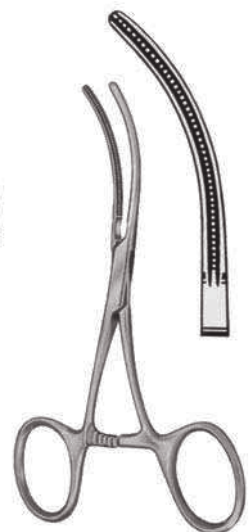

DE BAKEY  
 13.121.12  
 12,0 cm



cm	LEES
23,0	<b>13.131.23</b>
25,0	<b>13.131.25</b>

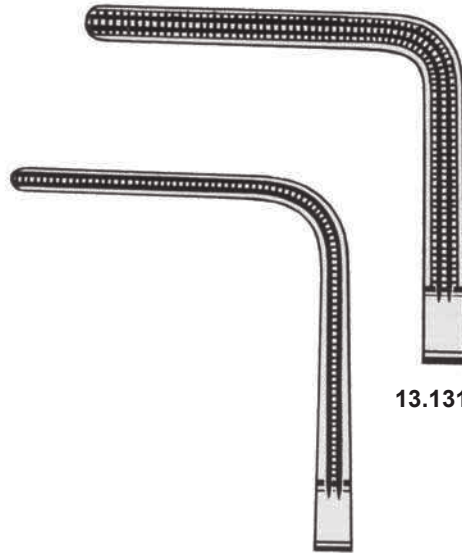

**13.131.25**

**13.131.23**

Bronchusklemmen  
Bronchus Forceps  
Pincés-Clamps à Bronches  
Pinzas clamps bronquiales  
Pinze per bronchi



LEES  
**13.133.25**  
25,0 cm

Coarctationsklemmen  
 Coarction Clamps  
 Pincès à coarctacion  
 Pinzas para coarctación  
 Pinze per coartazione

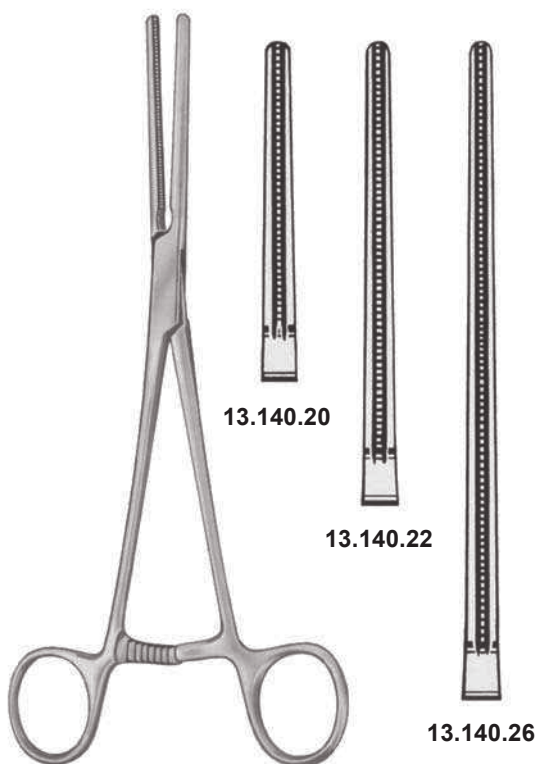

cm	POTTS
20,0	<b>13.140.20</b>
22,5	<b>13.140.22</b>
26,0	<b>13.140.26</b>

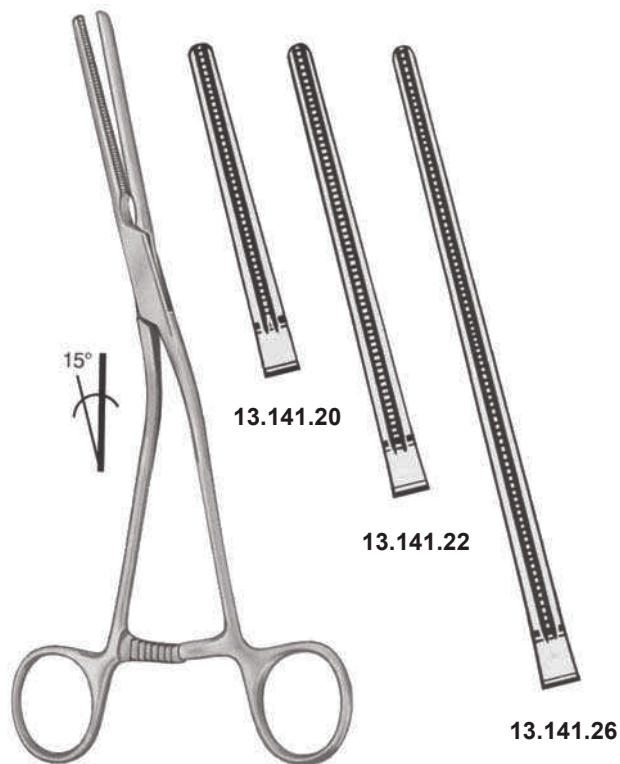

cm	GLOVER
20,0	<b>13.141.20</b>
22,5	<b>13.141.22</b>
26,0	<b>13.141.26</b>

Atraumatische Gefäßklemmen  
 Atraumatic Hemostatic Forceps  
 Pincés hémostatiques atraumatiques  
 Pinzas hemostáticas atraumáticas  
 Pinze emostatiche atraumatiche

**dimeda**<sup>®</sup>

SURGICAL INSTRUMENTS

Anastomosenklemmen  
 Anastomosis Clamps  
 Pincés à anastomose  
 Pinzas para anastomosis  
 Pinze per anastomosi



cm	POTTS / GLOVER
21,0	<b>13.151.21</b>
24,0	<b>13.151.24</b>



**13.151.21**

**13.151.24**



cm	GLOVER
18,0	<b>13.153.18</b>
22,0	<b>13.153.22</b>

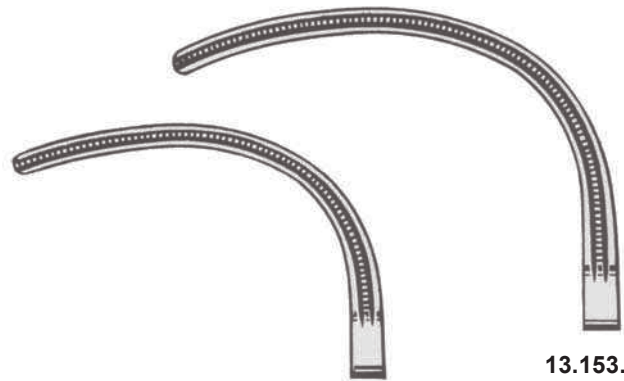

**13.153.18**

**13.153.22**

Atraumatische Gefäßklemmen  
 Atraumatic Hemostatic Forceps  
 Pincés hémostatiques atraumatiques  
 Pinzas hemostáticas atraumáticas  
 Pinze emostatiche atraumatiche

**dimeda**®

SURGICAL INSTRUMENTS

Vascularklemme löffelförmig  
 Vascular Clamps Spoon Shaped  
 Pince vasculaire forme cuiller  
 Pinza vascular forma cuchara  
 Pinza vascolare forma cucchiaio

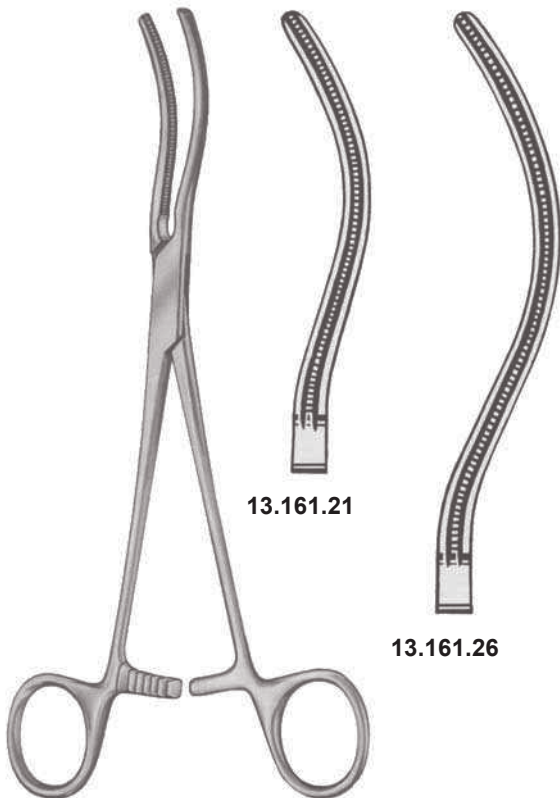

13.161.21

13.161.26

Peripher-Vascularklemmen  
 Peripheral Vascular Forceps  
 Pincés vasculaires périph.  
 Pinzas vasculares perif.  
 Pinze vascolari perif.

cm	GLOVER
21,0	13.161.21
26,0	13.161.26

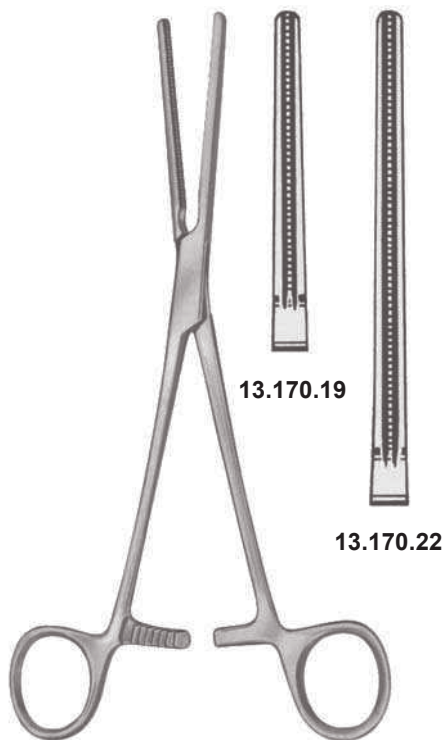

13.170.19

13.170.22

cm	DE BAKEY
18,0	13.170.19
22,0	13.170.22



13.171.19

13.171.22

cm	DE BAKEY
18,0	13.171.19
22,0	13.171.22

Atraumatische Mehrzweckklemmen  
 Atraumatic Multi-Purpose Clamps  
 Pincès-clamps polyvalentes  
 Pinzas clamps para usos varios  
 Pinze atraumatiche per diversi usi



DARDIK

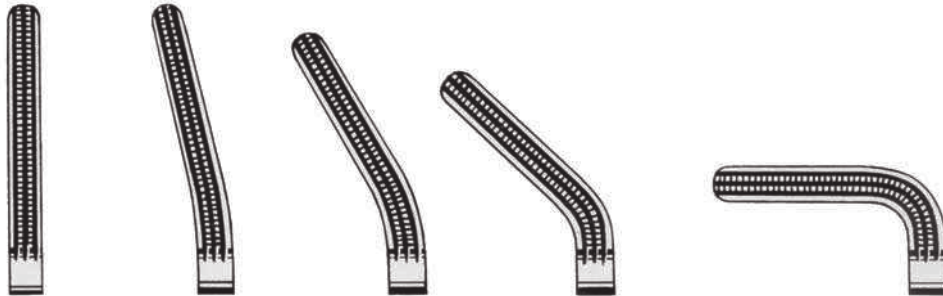

cm	0°	15°	30°	45°	90°
14,0	--	--	--	--	<b>13.172.90</b>
15,0	<b>13.172.00</b>	<b>13.172.15</b>	<b>13.172.30</b>	<b>13.172.45</b>	--

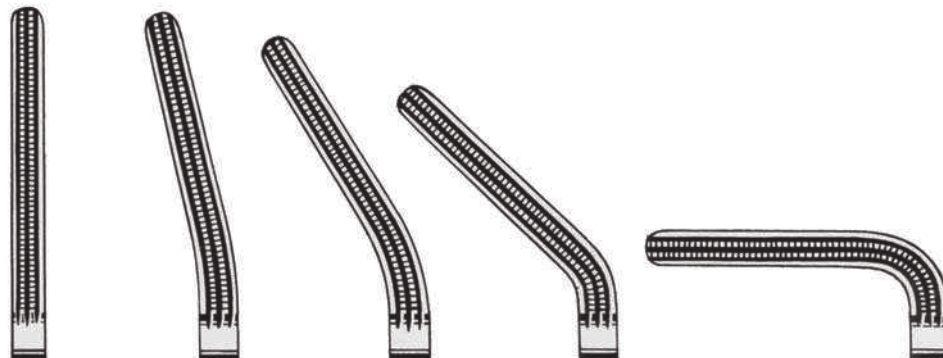

cm	0°	15°	30°	45°	90°
16,0	--	--	--	--	<b>13.174.90</b>
17,0	<b>13.174.00</b>	<b>13.174.15</b>	<b>13.174.30</b>	<b>13.174.45</b>	--

Peripher-Vascularklemmen  
 Peripheral Vascular Forceps  
 Pincés vasculaires périph.  
 Pinzas vasculares perif.  
 Pinze vascolari perif.

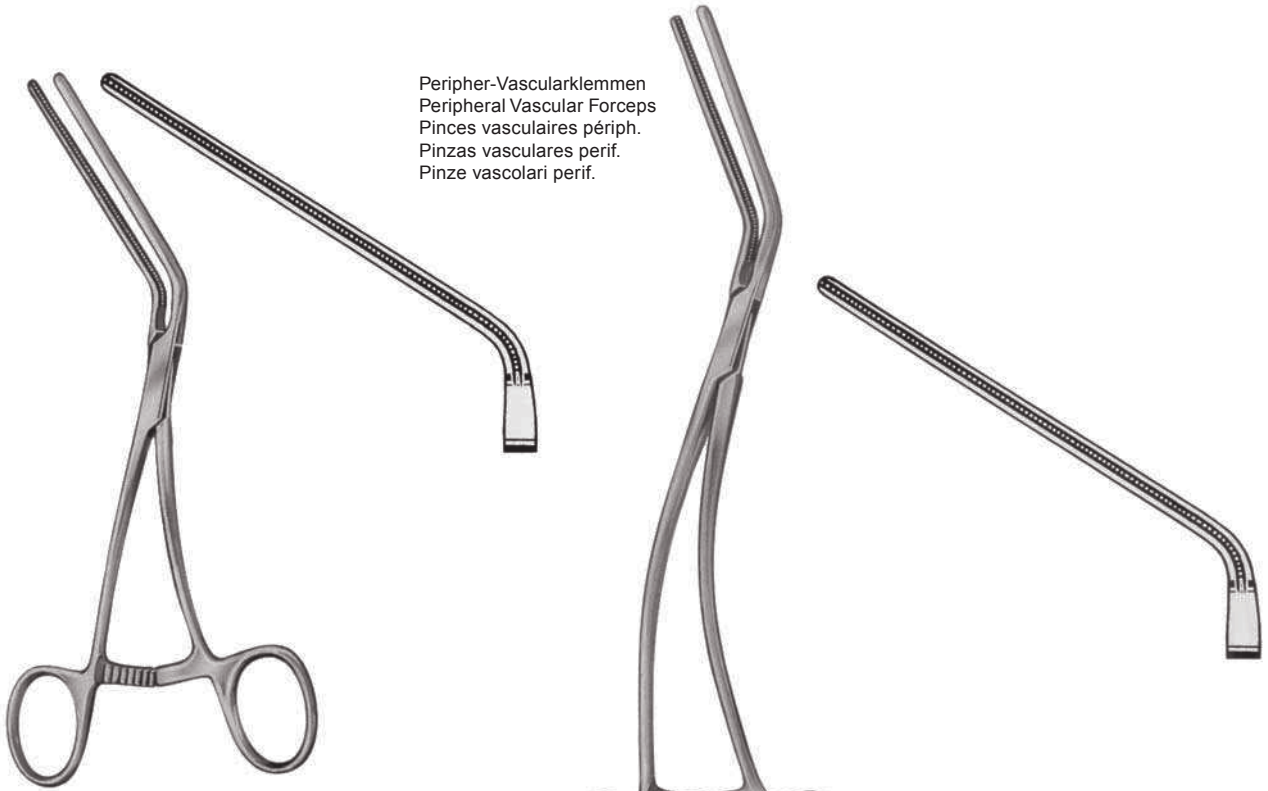

LELAND-JONES  
**13.181.19**  
 19,0 cm

DE BAKEY  
**13.181.26**  
 26,0 cm

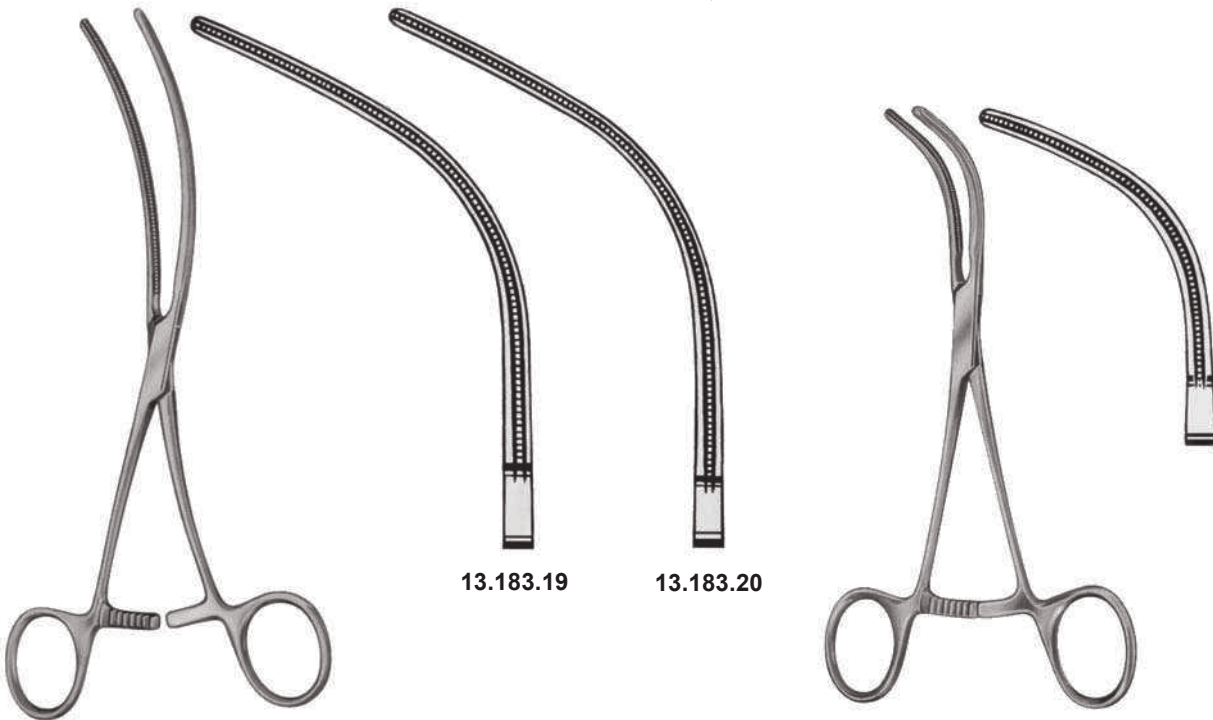

**13.183.19**

**13.183.20**

cm	DE BAKEY
19,0	<b>13.183.19</b>
20,0	<b>13.183.20</b>

DE BAKEY  
**13.191.16**  
 16,0 cm





BAINBRIDGE

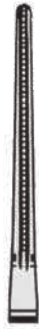

**13.196.15**  
15,0 cm



**13.196.18**  
18,0 cm



**13.197.15**  
15,0 cm



**13.197.18**  
18,0 cm

Peripher-Vascularklemmen  
 Peripheral Vascular Forceps  
 Pincès vasculaires périph.  
 Pinzas vasculares perif.  
 Pinze vascolari perif.

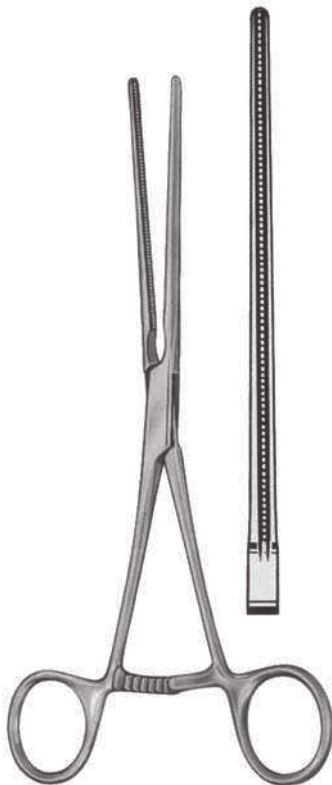

LELAND JONES  
**13.202.19**  
19,0 cm



**13.203.19**  
19,0 cm

**13.205.19**  
19,0 cm

LELAND JONES

Aortaklemmen  
Aortic Clamp  
Pince-clamp à aorte  
Pinza clamp para aorta  
Pinza per aorta



LIDDLE  
**13.209.27**  
27,0 cm

Aorta-Anastomosenklemmen  
Aorta-Anastomosis Clamps  
Pincés-clamps pour anastomoses d'aorte  
Pinzas clamps para anastomosis de aorta  
Pinze aortiche



LAMBERT KAY  
**13.211.20**  
20,0 cm

Iliaca-Klemme  
Iliac Clamp  
Pince-clamp à iliaque  
Pinza clamp para iliaca  
Pinza per iliaca



LAMBERT KAY  
**13.213.20**  
20,0 cm



DE BAKEY  
**13.215.20**  
20,0 cm



links gebogen  
curved to left  
courbe à gauche  
curva a la izquierda  
curva a sinistra



WEBER  
13.217.26  
26,0 cm



rechts gebogen  
curved to right  
courbe à droite  
curva a la derecha  
curva a destra



WEBER  
13.219.26  
26,0 cm

Aorta-Aneurysma-Klemmen  
Aorta-Aneurysm Clamps  
Pincés-clamps pour aneurysme d'aorte  
Pinzas clamps para aneurisma de aorta  
Pinze per aneurisma di aorta



DE BAKEY

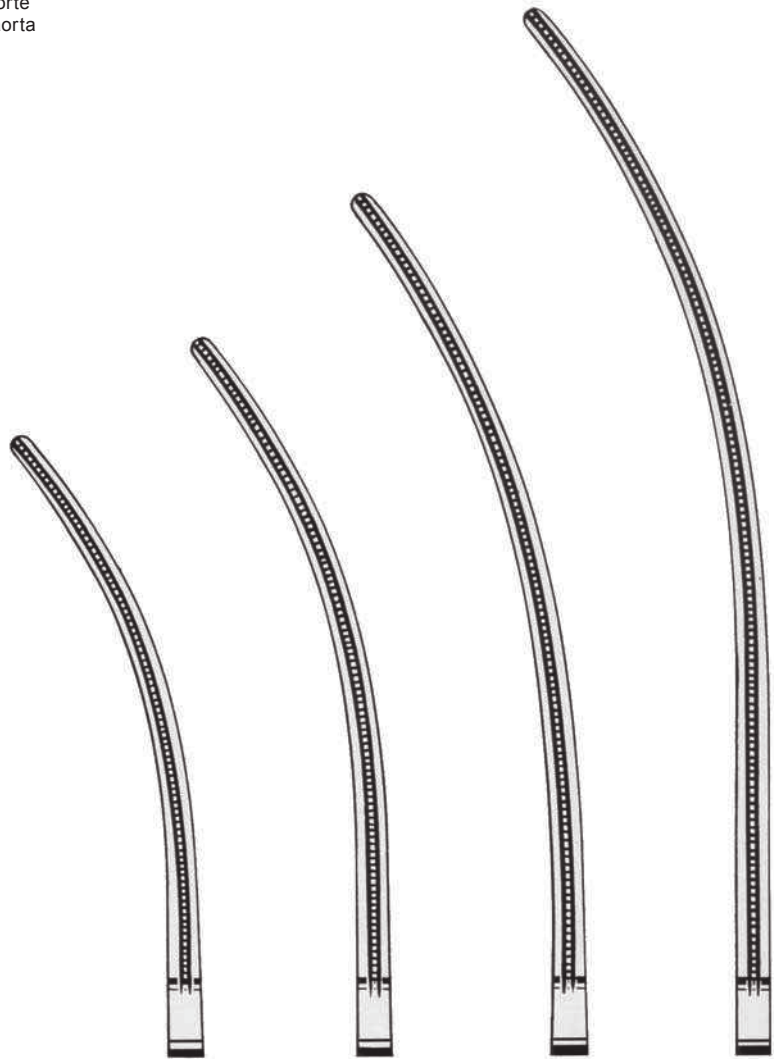

**13.221.24**  
**13.221.35**  
24,0 cm

**13.221.27**  
27,0 cm

**13.221.31**  
31,0 cm

35,0 cm

Aorta-Aneurysma-Klemmen  
Aorta-Aneurysm Clamps  
Pinces-clamps pour aneurysme d'aorte  
Pinzas clamps para aneurisma de aorta  
Pinze per aneurisma di aorta



DE BAKEY BAHNSON



**13.223.24**  
24,0 cm

**13.223.25**  
25,0 cm

**13.223.26**  
26,0 cm

Aorta-Aneurysma-Klemmen  
Aorta-Aneurysm Clamps  
Pinces-clamps pour aneurysme d'aorte  
Pinzas clamps para aneurisma de aorta  
Pinze per aneurisma di aorta

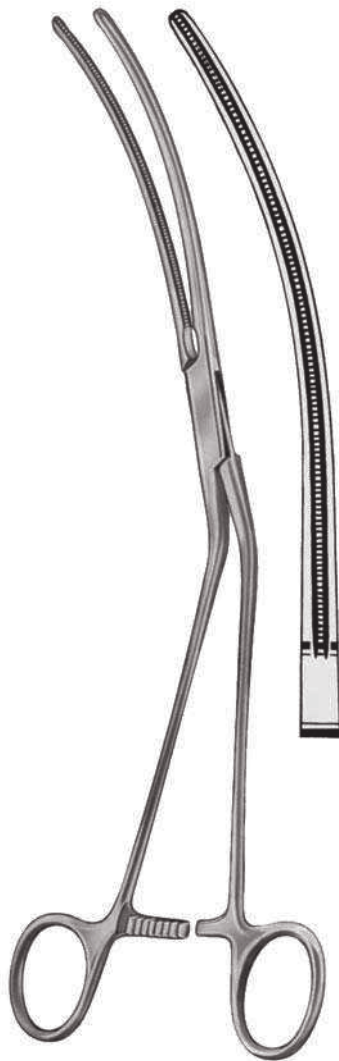

DE BAKHEY  
**13.225.28**  
28,0 cm

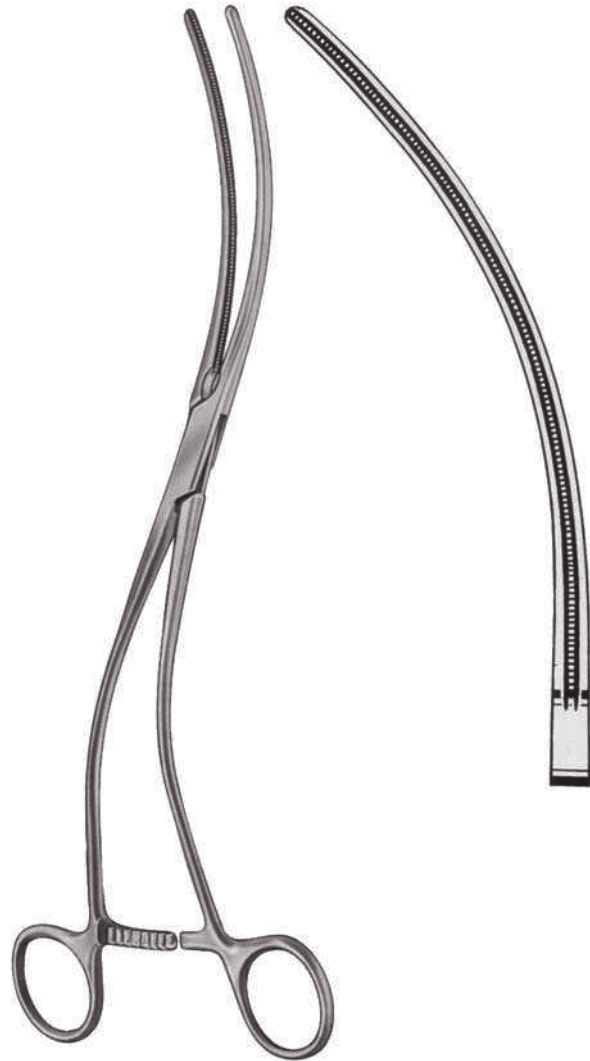

DE BAKHEY  
**13.227.28**  
28,0 cm

Atraumatische Gefäßklemmen  
Atraumatic Hemostatic Forceps  
Pinces hémostatiques atraumatiques  
Pinzas hemostáticas atraumáticas  
Pinze emostatiche atraumatiche

**dimeda**<sup>®</sup>

SURGICAL INSTRUMENTS

Atraumatische Mehrzweckklemmen  
Atraumatic Multi-Purpose Clamps  
Pinces-clamps polyvalentes  
Pinzas clamps para usos varios  
Pinze atraumatiche per diversi usi



DE BAKEY MORRIS

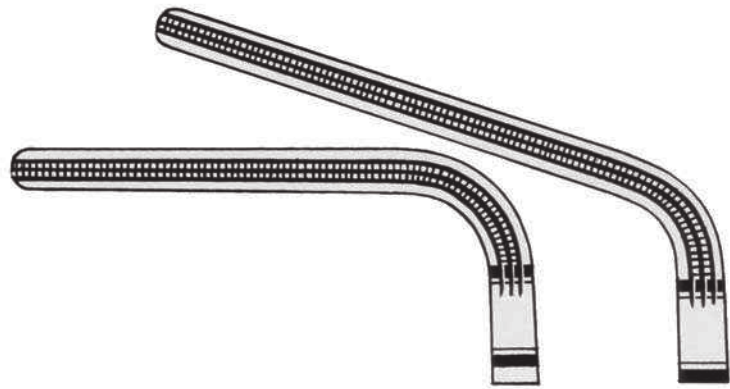

**13.229.18**  
18,0 cm

**13.229.20**  
20,0 cm

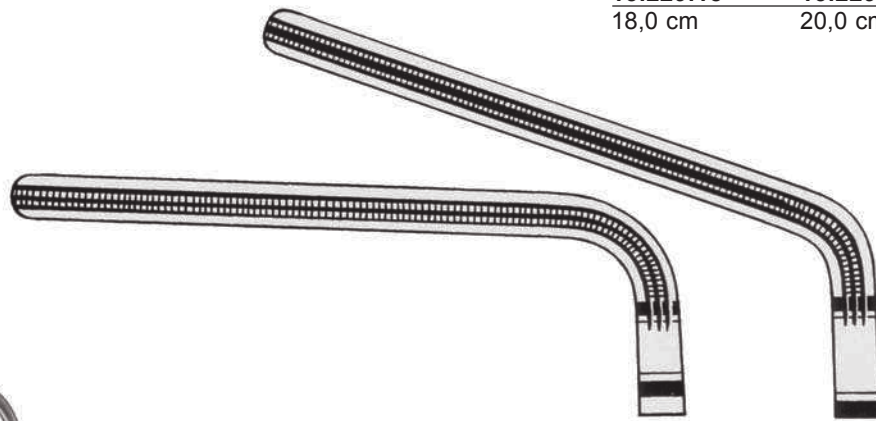

**13.229.23**  
23,0 cm

**13.229.25**  
25,0 cm



Atraumatische Gefäßklemmen  
Atraumatic Hemostatic Forceps  
Pincas hémostatiques atraumatiques  
Pinzas hemostáticas atraumáticas  
Pinze emostatiche atraumatiche

**dimeda**<sup>®</sup>

SURGICAL INSTRUMENTS

Atraumatische Mehrzweckklemmen  
Atraumatic Multi-Purpose Clamps  
Pincas-clamps polyvalentes  
Pinzas clamps para usos varios  
Pinze atraumatiche per diversi usi



DE BAKEY



**13.231.18**  
18,0 cm

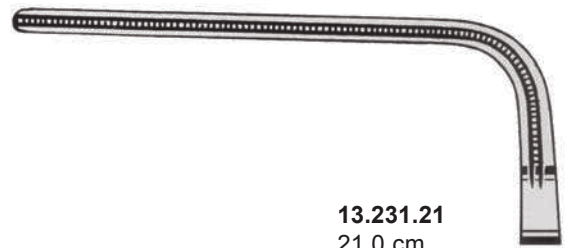

**13.231.21**  
21,0 cm

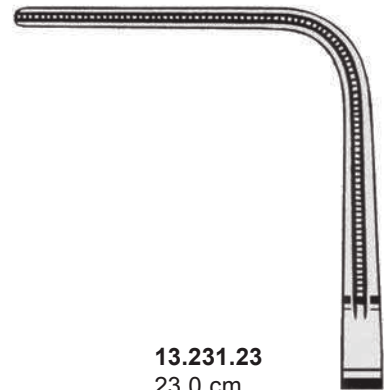

**13.231.23**  
23,0 cm



**13.231.27**  
27,0 cm

Atraumatische Gefäßklemmen  
Atraumatic Hemostatic Forceps  
Pincés hémostatiques atraumatiques  
Pinzas hemostáticas atraumáticas  
Pinze emostatiche atraumatiche

**dimeda**<sup>®</sup>

SURGICAL INSTRUMENTS

Aorta-Aneurysma-Klemmen  
Aorta-Aneurysm Clamps  
Pincés-clamps pour aneurysme d'aorte  
Pinzas clamps para aneurisma de aorta  
Pinze per aneurisma di aorta



DE BAKEY

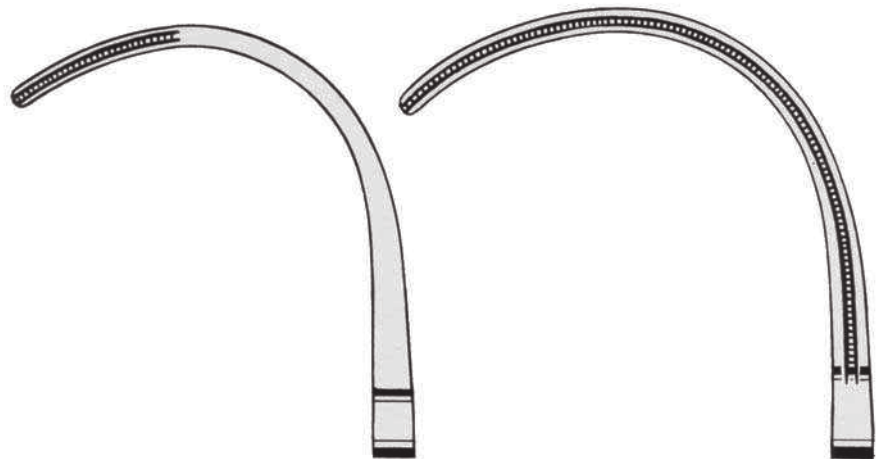

**13.241.25**  
25,0 cm

**13.241.26**  
26,0 cm

Bronchus-Klemmen  
Bronchus Clamps  
Pincés pour les bronches  
Pinzas bronquiales  
Pinze per bronchi



DE BAKEY  
13.247.27  
27,0 cm



DE BAKEY

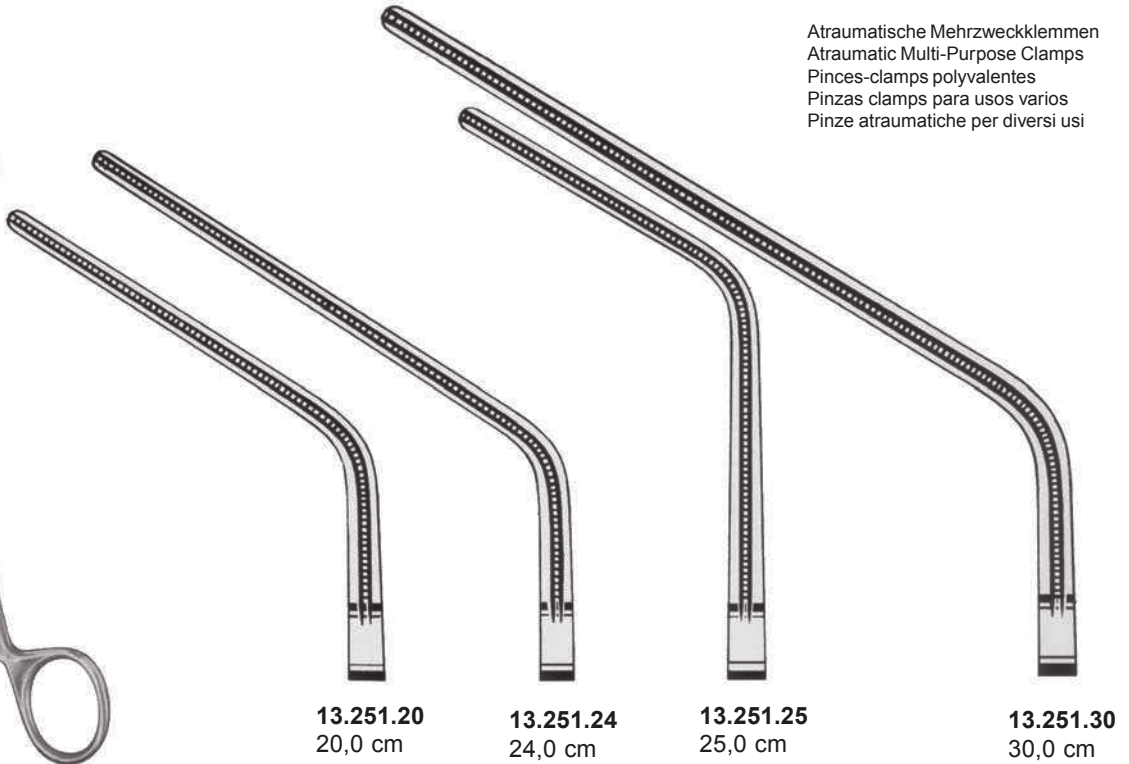

Atraumatische Mehrzweckklemmen  
 Atraumatic Multi-Purpose Clamps  
 Pincas-clamps polyvalentes  
 Pinzas clamps para usos varios  
 Pinze atraumatiche per diversi usi

**13.251.20**  
20,0 cm

**13.251.24**  
24,0 cm

**13.251.25**  
25,0 cm

**13.251.30**  
30,0 cm



SATINSKY

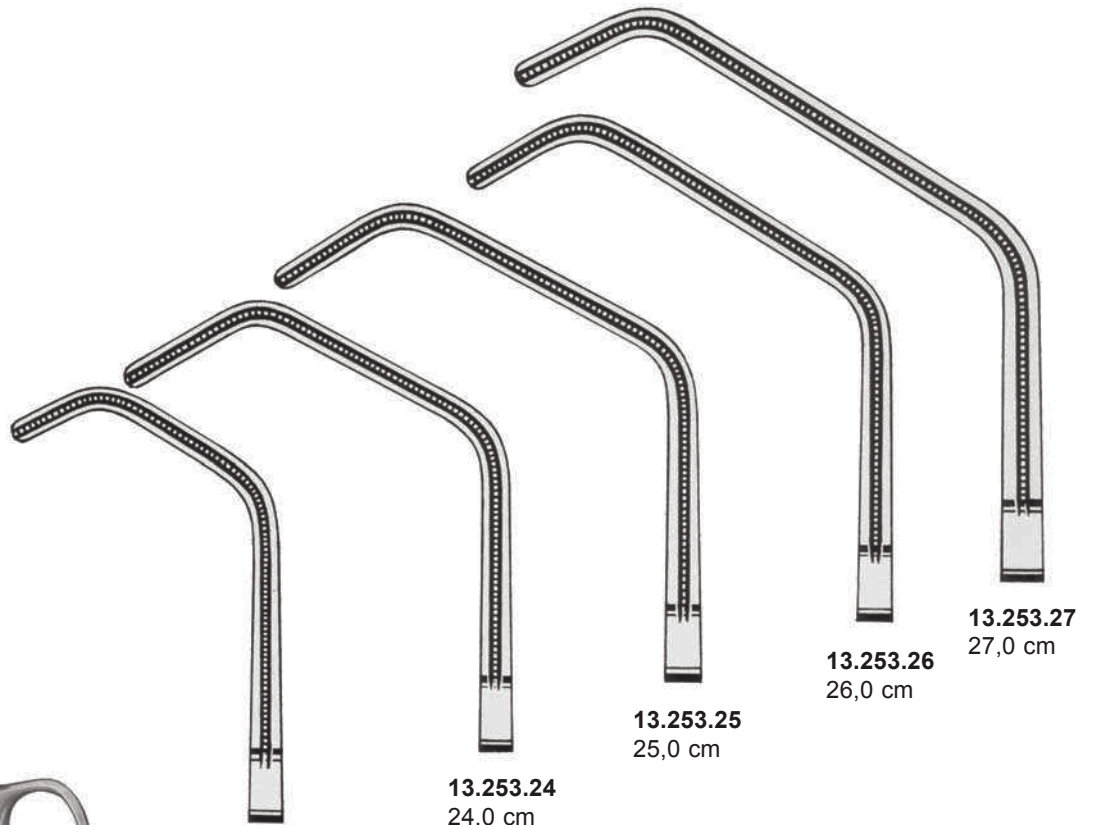

**13.253.20**  
20,0 cm

**13.253.24**  
24,0 cm

**13.253.25**  
25,0 cm

**13.253.26**  
26,0 cm

**13.253.27**  
27,0 cm

Anlegezange für Clips  
 Applying for Clips  
 Applicateur pour clips  
 Pinza para aplicar clips  
 Applicatore per clips

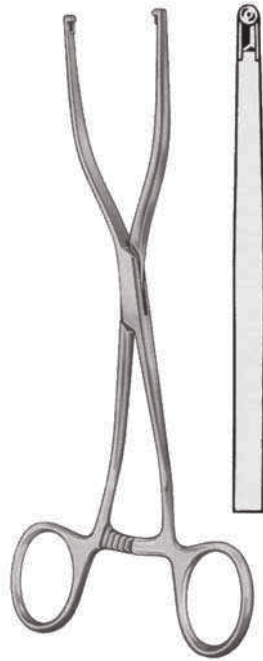

EDWARDS  
 13.258.00

Clips  
 Clips  
 Clips  
 Clips  
 Clips

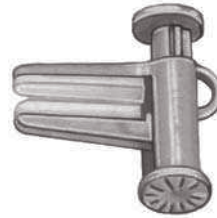

mm	EDWARDS
6	<b>13.258.06</b>
12	<b>13.258.12</b>



WYLIE

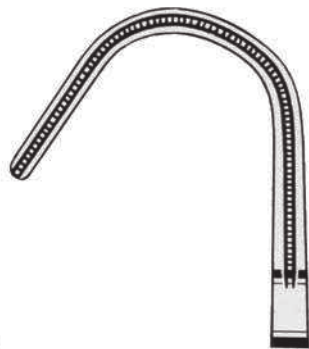

**13.259.01**  
 Fig. 1  
 21,0 cm

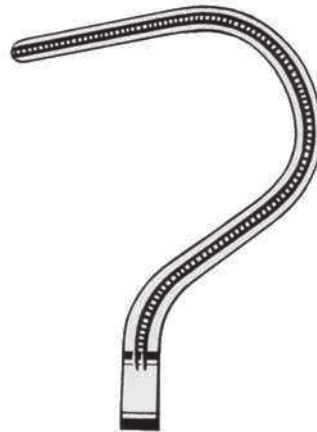

**13.259.02**  
 Fig. 2  
 22,0 cm



DE BAKEY SATINSKY



**13.261.23**  
Fig. 1  
23,0 cm

**13.261.24**  
Fig. 2  
24,0 cm

**13.261.25**  
Fig. 3  
25,0 cm

Aurikelklemmen  
Auricle Clamps  
Pincés auriculaires  
Pinzas para aurícula  
Pinze ventricolari



**13.263.25**  
Fig. 1  
25,0 cm



**13.265.24**  
Fig. 2  
24,0 cm



**13.267.24**  
Fig. 3  
24,0 cm



**13.269.24**  
Fig. 4  
24,0 cm



Atraumatische Gefäßklemmen  
Atraumatic Hemostatic Forceps  
Pincés hémostatiques atraumatiques  
Pinzas hemostáticas atraumáticas  
Pinze emostatiche atraumatiche

**dimeda**<sup>®</sup>

SURGICAL INSTRUMENTS

Peripheal-Gefäßklemmen  
Peripheal Vascular Clamps  
Pincés-clamps, vasculaires périphériques  
Pinzas para vasos periféricos  
Pinze vascolari periferali



DALE  
**13.271.18**  
18,0 cm

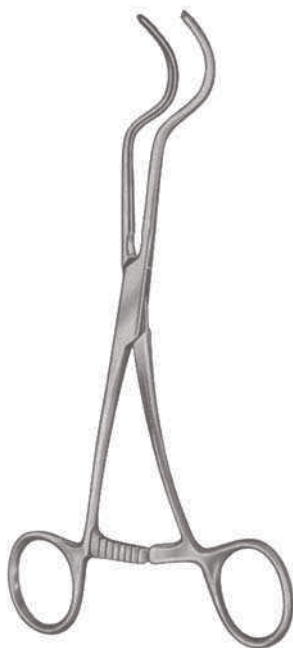

DALE



**13.273.17**  
17,0 cm

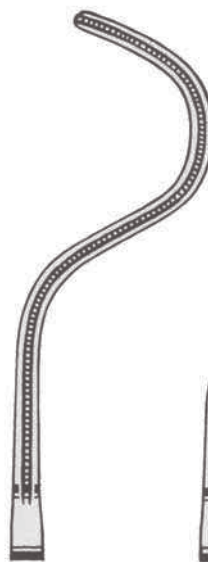

**13.273.18**  
18,0 cm

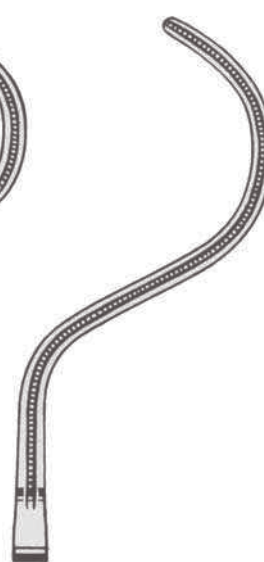

**13.273.19**  
19,0 cm



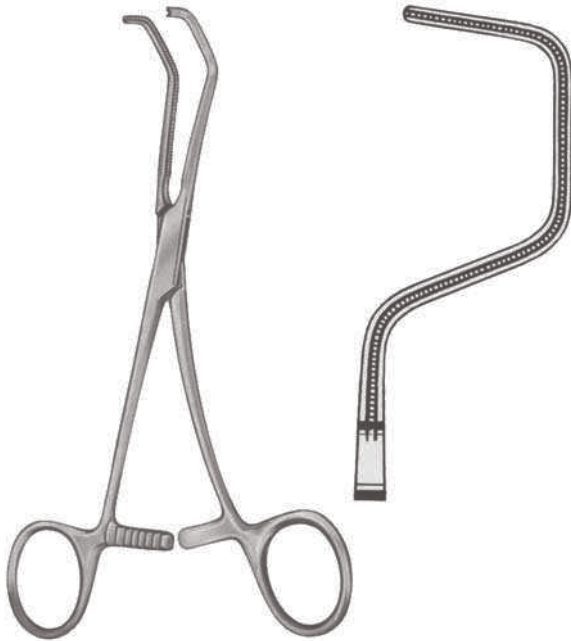

DE BAKEY  
**13.281.17**  
17,0 cm



BECK  
**13.283.17**  
17,0 cm

Präparier- und Ligaturklemmen  
Dissecting and Ligature Clamps  
Pincas à dissection et passe-fil  
Pinzas de disección y para ligaduras  
Pinze per dissezione e per legature

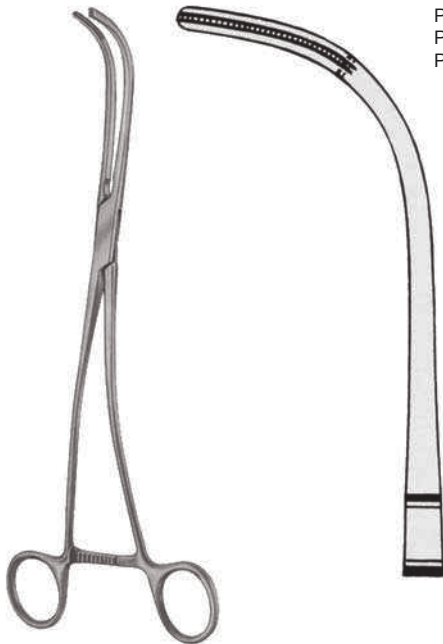

DE BAKEY  
**13.285.24**  
24,0 cm

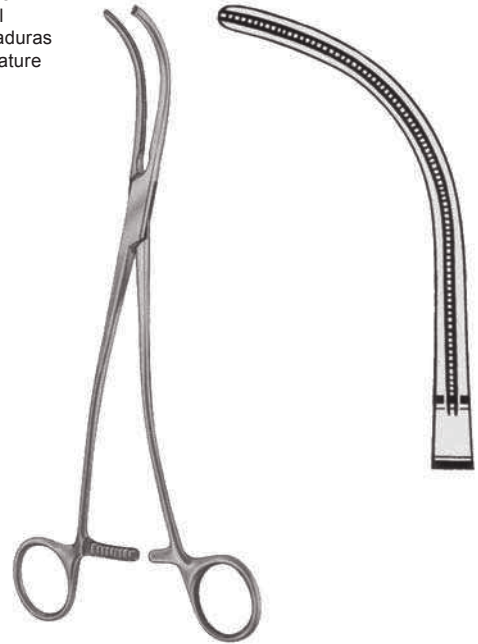

DE BAKEY  
**13.287.24**  
24,0 cm

Atraumatische Mehrzweckklemmen  
Atraumatic Multi-Purpose Clamps  
Pincès-clamps polyvalentes  
Pinzas clamps para usos varios  
Pinze atraumatiche per diversi usi



POTTS



13.288.21  
21,0 cm



13.288.23  
23,0 cm



13.288.27  
27,0 cm



13.288.31  
31,0 cm

Atraumatische Mehrzweckklemmen  
Atraumatic Multi-Purpose Clamps  
Pincas-clamps polyvalentes  
Pinzas clamps para usos varios  
Pinze atraumatiche per diversi usi



POTTS



**13.289.21**  
21,0 cm

**13.289.23**  
23,0 cm

**13.289.27**  
27,0 cm

**13.289.31**  
31,0 cm

Anastomosenklemmen, Kindergrößen  
Anastomosis Clamps, Pediatric  
Pincés à anastomose, pédiatriques  
Pinzas para anastomosis, pediátricas  
Pinze per anastomosi, pediatriche

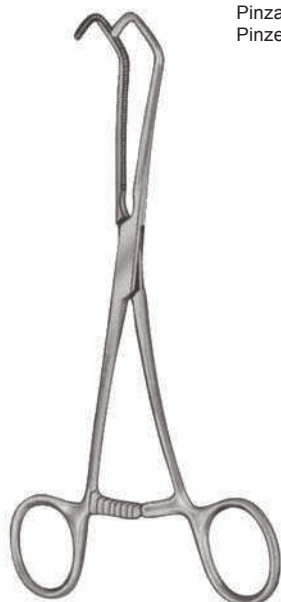

DERRA

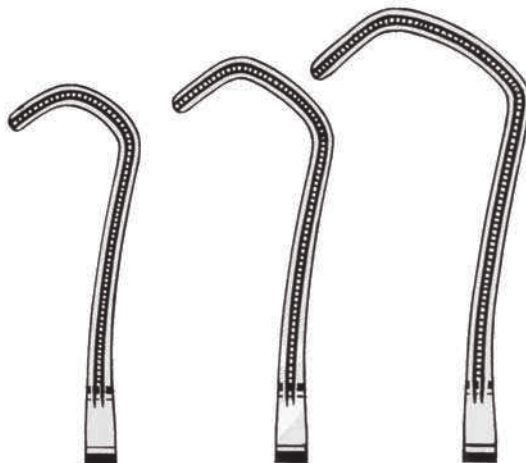

**13.291.16**  
16,0 cm

**13.291.17**  
17,0 cm

**13.291.18**  
18,0 cm

Atraumatische Mehrzweckklemmen  
Atraumatic Multi-Purpose Clamps  
Pincés-clamps polyvalentes  
Pinzas clamps para usos varios  
Pinze atraumatiche per diversi usi



DE BAKEY  
**13.302.16**  
16,0 cm



DE BAKEY  
**13.302.17**  
17,0 cm



DE BAKEY  
**13.303.15**  
15,0 cm



DE BAKEY  
**13.307.17**  
17,0 cm

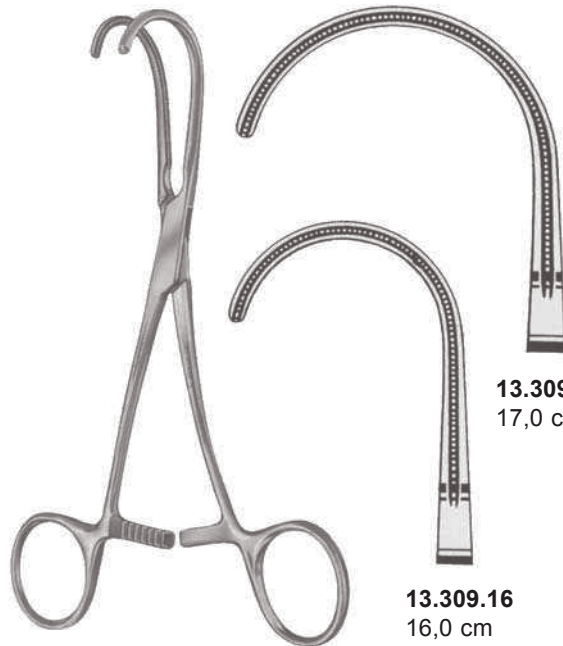

DE BAKEY

**13.309.17**  
17,0 cm

**13.309.16**  
16,0 cm

Atraumatische Mehrzweckklemmen  
 Atraumatic Multi-Purpose Clamps  
 Pincas-clamps polyvalentes  
 Pinzas clamps para usos varios  
 Pinze atraumatiche per diversi usi



DE BAKEY

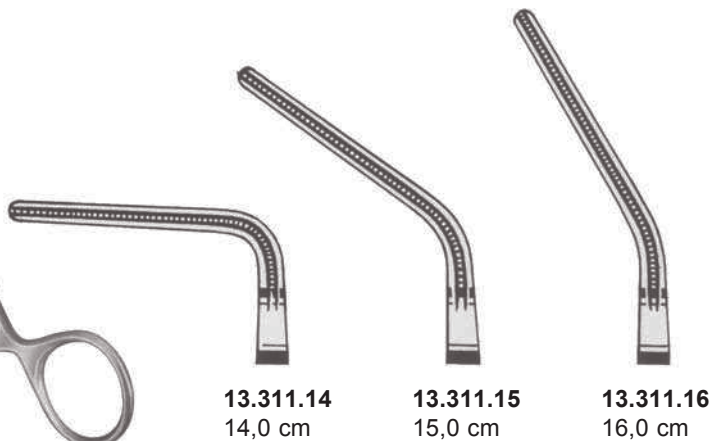

**13.311.14**  
14,0 cm

**13.311.15**  
15,0 cm

**13.311.16**  
16,0 cm



GLOVER  
**13.321.17**  
17,0 cm

Anastomosenklemmen  
 Anastomosis Clamps  
 Pincas à anastomose  
 Pinzas para anastomosis  
 Pinze per anastomosi

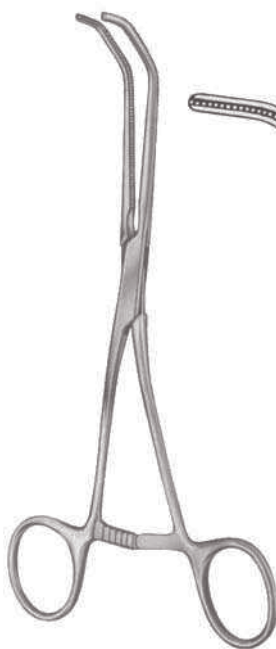

DE BAKEY REYNOLDS

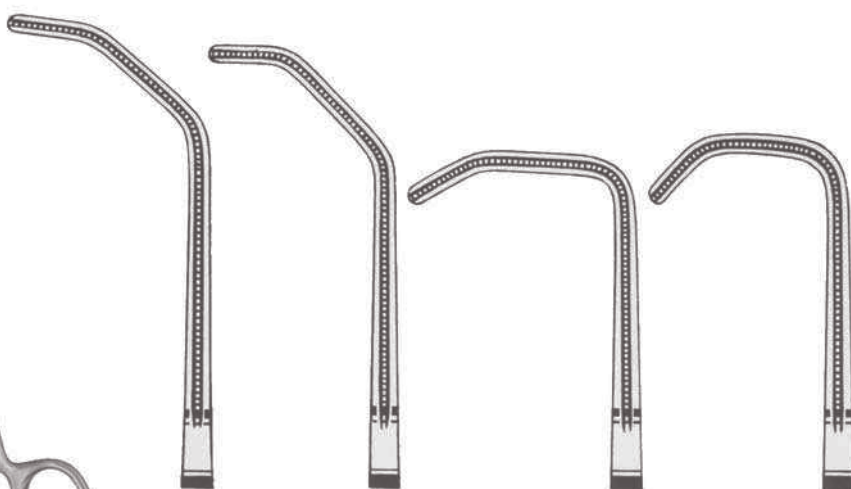

**13.329.01**  
Fig. 1  
17,5 cm

**13.329.02**  
Fig. 2  
17,5 cm

**13.329.03**  
Fig. 3  
16,5 cm

**13.329.04**  
Fig. 3  
16,5 cm

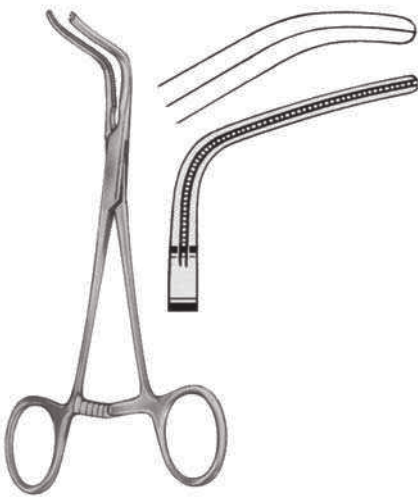

SUBRAMANIAN  
**13.331.15**  
15,0 cm

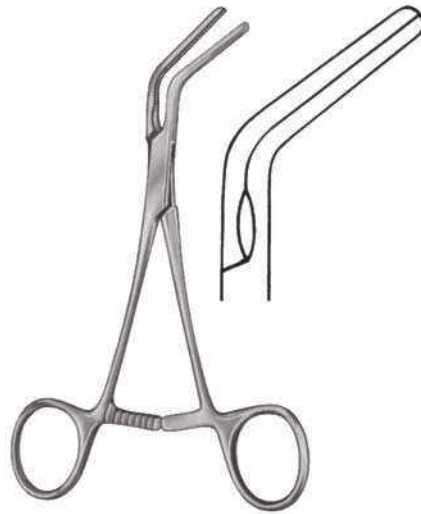

SUBRAMANIAN  
**13.333.16**  
16,0 cm

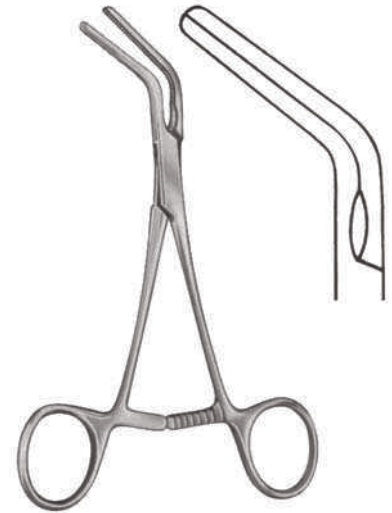

SUBRAMANIAN  
**13.335.16**  
16,0 cm



OCHSNER  
**13.337.23**  
23,0 cm

Aortaklemmen  
Aortic Clamp  
Pince-clamp à aorte  
Pinza clamp para aorta  
Pinza per aorta



DIETRICH  
**13.339.21**  
21,0 cm

Atraumatische Gefäßklemmen  
 Atraumatic Hemostatic Forceps  
 Pincas hémostatiques atraumatiques  
 Pinzas hemostáticas atraumáticas  
 Pinze emostatiche atraumatiche

**dimed**<sup>®</sup>

SURGICAL INSTRUMENTS

Präparier- und Ligaturklemmen  
 Dissecting and Ligature Clamps  
 Pincas à dissection et passe-fil  
 Pinzas de dissección y para ligaduras  
 Pinze per dissezione e per legature



DE BAKEY



**13.341.19**  
19,0 cm



**13.341.20**  
20,0 cm



**13.341.23**  
23,0 cm

Carotis-Shuntklemmen  
 Carotid Shunt Clamps  
 Pincas pour carotide  
 Pinzas para shunt carótido  
 Pinze carotis

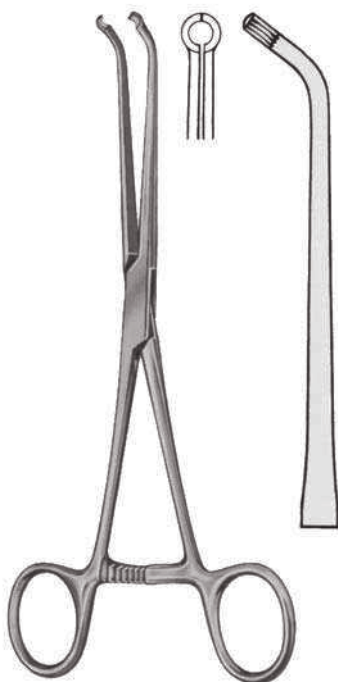

JAVID  
**13.343.18**  
18,0 cm

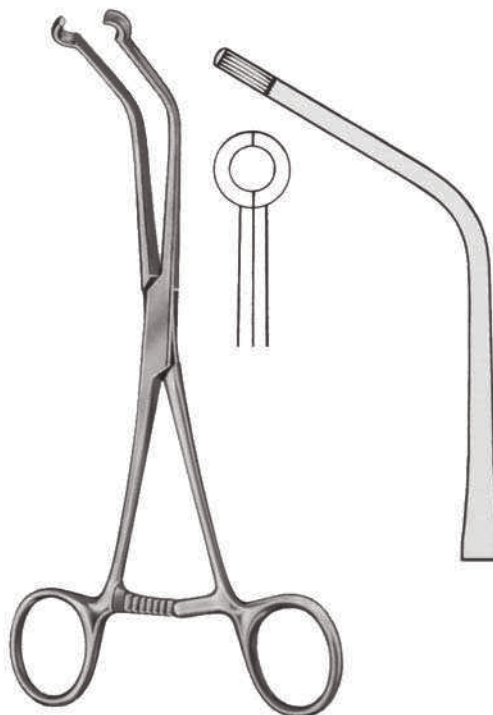

JAVID  
**13.343.19**  
19,0 cm



Profunda-Klemmen  
 Profunda Clamps  
 Pincés-clamps pour profunda  
 Pinzas clamps para profunda  
 Pinze per profunda



GREGORY

**13.349.14**  
 14,0 cm



**13.349.16**  
 16,0 cm

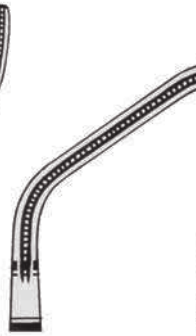

**13.349.18**  
 18,0 cm

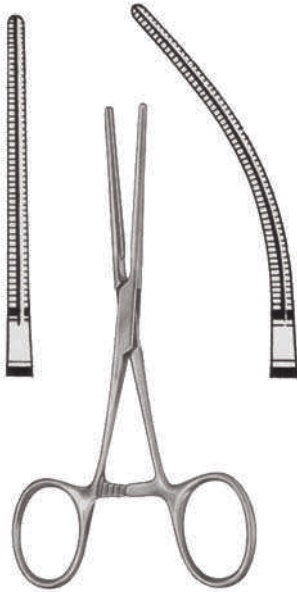
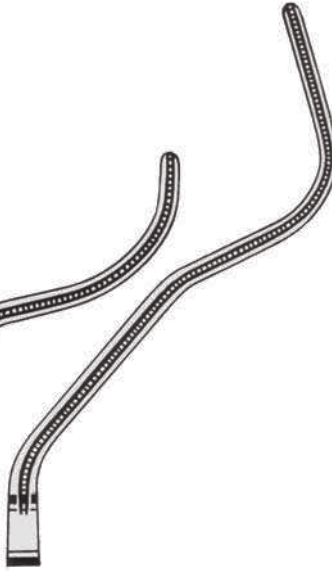

cm — COOLEY —  
**13.350.13**  
**13.351.13**

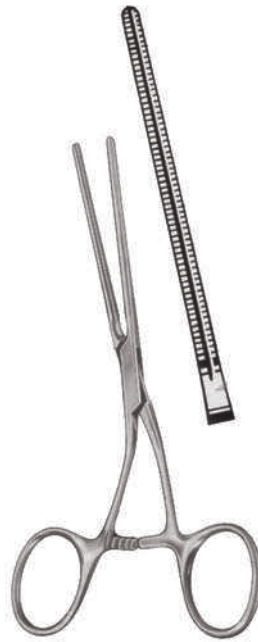

COOLEY  
**13.353.13**  
 13,5 cm



COOLEY  
**13.355.13**  
 13,0 cm



COOLEY  
**13.357.12**  
12,5 cm



COOLEY  
**13.359.10**  
10,5 cm

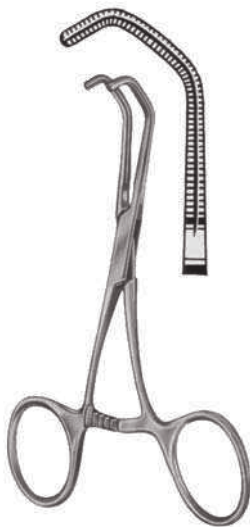

COOLEY  
**13.361.12**  
12,0 cm



COOLEY  
**13.363.13**  
13,5 cm

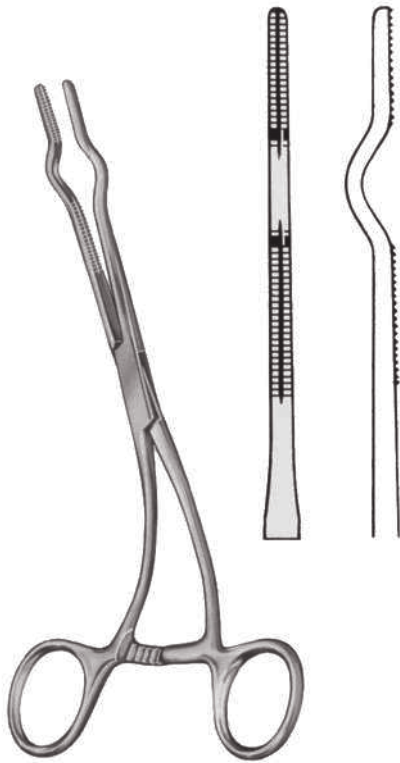

Fr./Charrière	COOLEY
24	13.371.24
26	13.371.26
28	13.371.28
30	13.373.30
32	13.373.32
36	13.373.36



cm	COOLEY
14,0	13.376.14
	13.377.14
16,0	13.376.16
	13.377.16

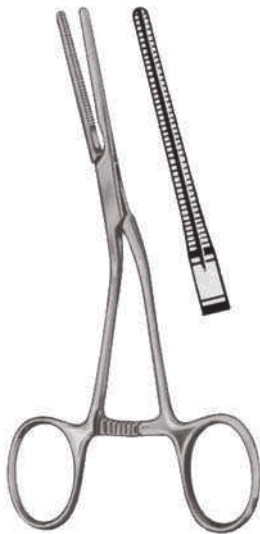

COOLEY  
 13.379.14  
 14,0 cm

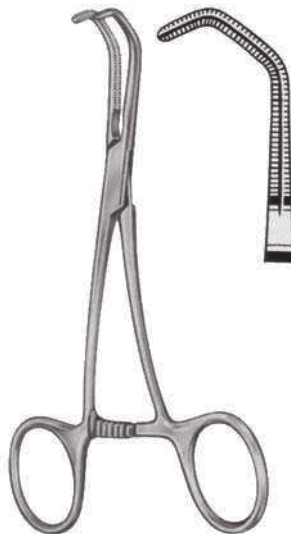

COOLEY  
 13.380.14  
 14,0 cm



COOLEY  
 13.381.14  
 14,0 cm



COOLEY  
13.405.27  
27,0 cm



COOLEY  
13.410.17  
17,0 cm

Atraumatische Gefäßklemmen  
 Atraumatic Hemostatic Forceps  
 Pincés hémostatiques atraumatiques  
 Pinzas hemostáticas atraumáticas  
 Pinze emostatiche atraumatiche

**dimeda**®

SURGICAL INSTRUMENTS

Atraumatische Mehrzweckklemmen  
 Atraumatic Multi-Purpose Clamps  
 Pincés-clamps polyvalentes  
 Pinzas clamps para usos varios  
 Pinze atraumatiche per diversi usi



COOLEY



**13.411.17**  
17,0 cm



**13.413.17**  
17,0 cm



**13.416.17**  
17,0 cm

Iliaca-Klemmen  
 Iliac Clamps  
 Pincés-clamps à iliaque  
 Pinzas clamps para iliaca  
 Pinze per iliaca



COOLEY  
**13.417.21**  
21,5 cm

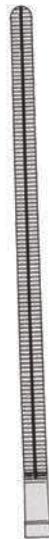

Anastomosenklemmen  
 Anastomosis Clamps  
 Pincés à anastomose  
 Pinzas para anastomosis  
 Pinze per anastomosi



COOLEY  
**13.419.17**  
17,0 cm



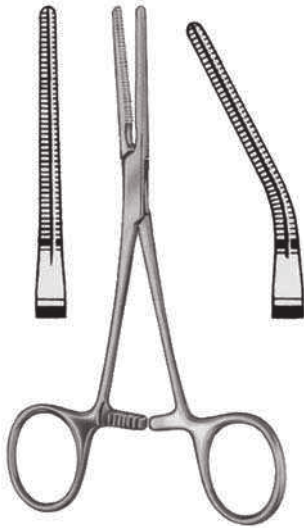

cm — COOLEY —  
 14,0 13.420.14  
 13.421.14



COOLEY  
 13.423.14  
 14,0 cm

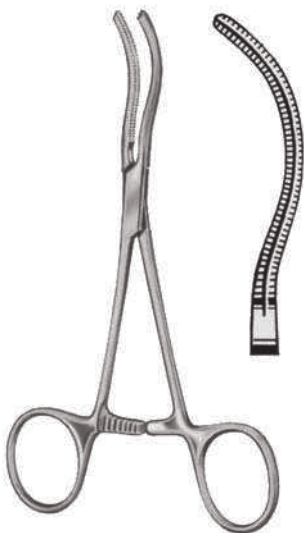

COOLEY  
 13.425.14  
 14,0 cm

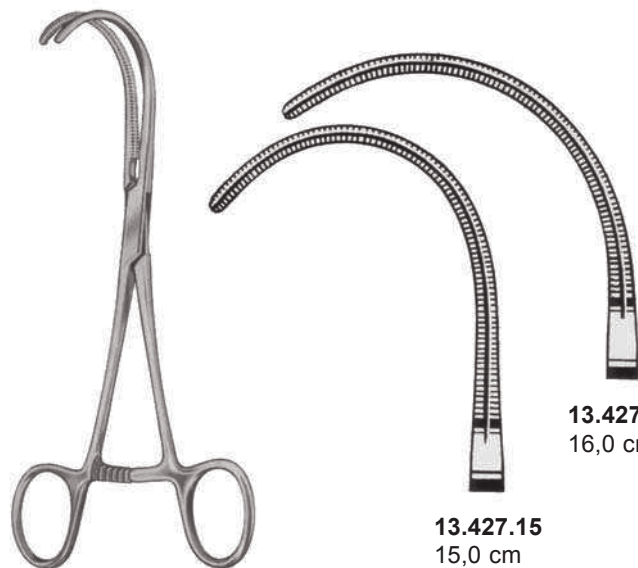

COOLEY

13.427.15  
 15,0 cm

13.427.16  
 16,0 cm

Atraumatische Mehrzweckklemmen  
 Atraumatic Multi-Purpose Clamps  
 Pincés-clamps polyvalentes  
 Pinzas clamps para usos varios  
 Pinze atraumatiche per diversi usi

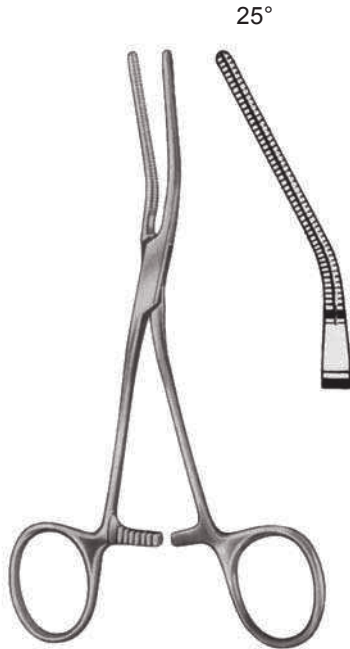

COOLEY  
**13.431.25**  
 16,5 cm

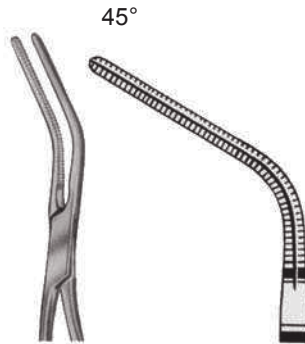

COOLEY  
**13.431.45**  
 16,5 cm

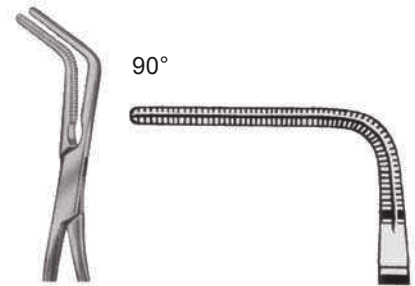

COOLEY  
**13.431.90**  
 16,5 cm

Anastomosenklemmen  
 Anastomosis Clamps  
 Pincés à anastomose  
 Pinzas para anastomosis  
 Pinze per anastomosi



COOLEY  
**13.433.14**  
 14,0 cm

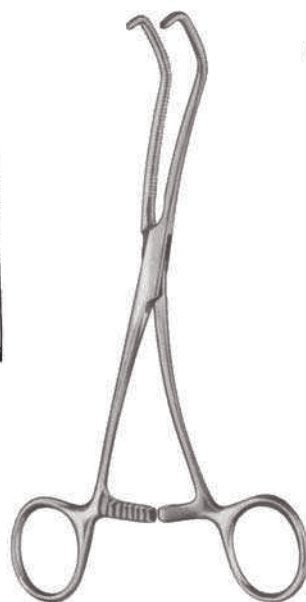

COOLEY DERRA

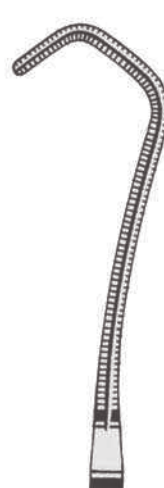

**13.441.16**  
 16,0 cm

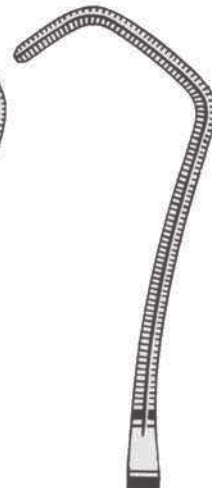

**13.441.17**  
 17,0 cm

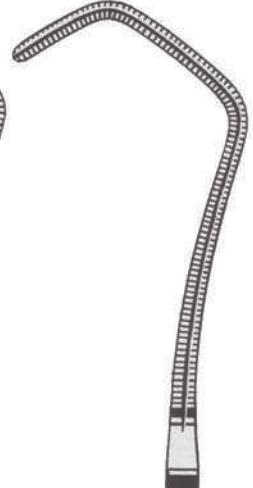

**13.441.18**  
 18,0 cm

Anastomosenklemmen  
Anastomosis Clamps  
Pincas à anastomose  
Pinzas para anastomosis  
Pinze per anastomosi



COOLEY  
17,0 cm

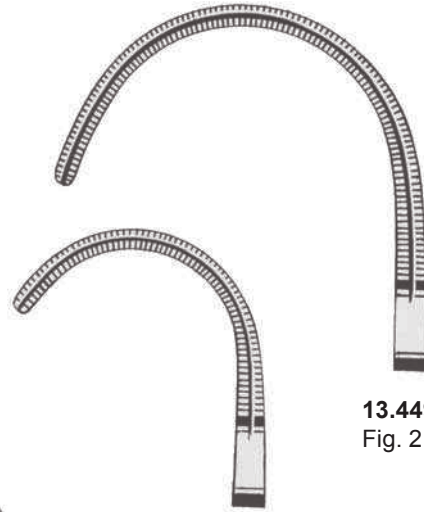

13.447.17  
Fig. 1

13.449.17  
Fig. 2



COOLEY

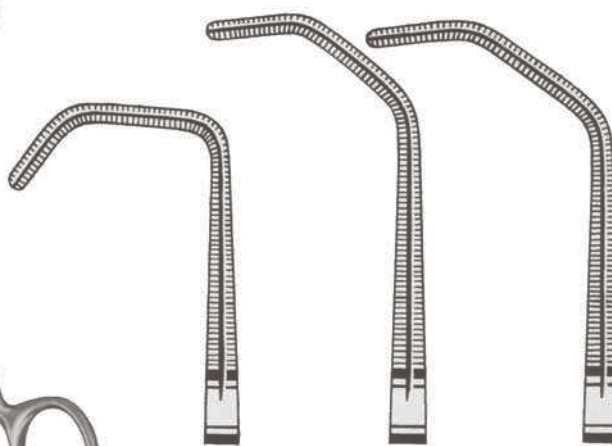

13.451.16  
16,0 cm

13.453.16  
17,5 cm

13.455.17  
17,5 cm





COOLEY  
**13.457.17**  
17,0 cm

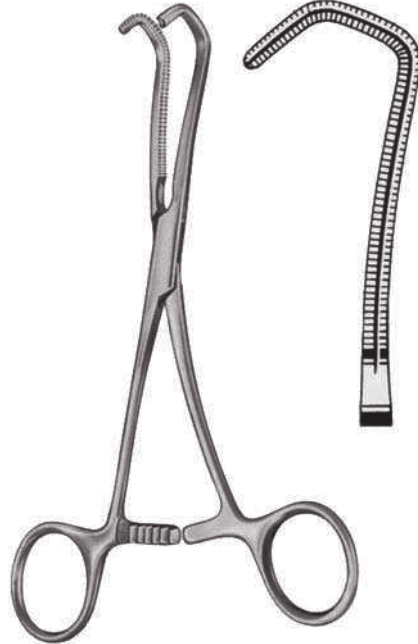

COOLEY  
**13.461.17**  
17,0 cm



COOLEY  
**13.465.18**  
18,0 cm



COOLEY  
**13.465.19**  
19,0 cm



COOLEY  
**13.465.26**  
26,0 cm

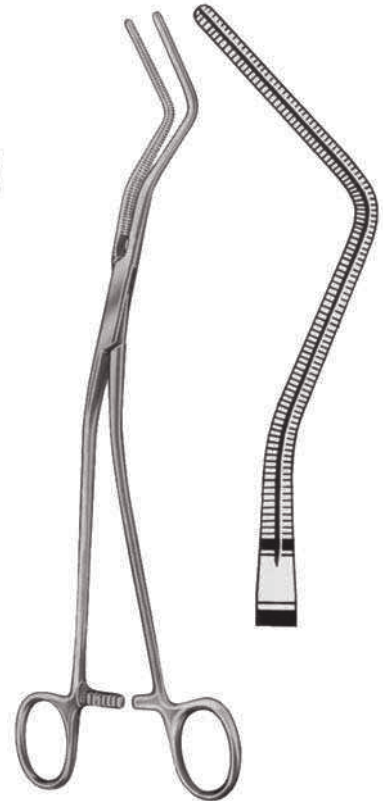

COOLEY  
**13.467.27**  
27,0 cm

Neonatal- und Kinderklemmen, extra feine Modelle  
 Neonatal and Childrens Clamps, extra delicate patterns  
 Pincés-clamps pour des nouveaux-nés et des enfants, modèles très fins  
 Pinzas clamps para recién nacidos y niños, modelos muy finos  
 Pinze pediatriche, modelli molto fini



**CASTAÑEDA**  
**13.481.13**  
 13,0 cm



**CASTAÑEDA**  
 13,0 cm

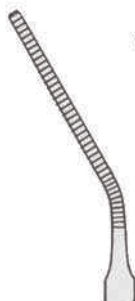

**13.483.13**  
 Fig. 1  
 13,0 cm

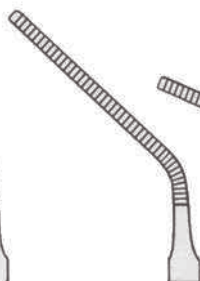

**13.485.13**  
 Fig. 2  
 13,0 cm

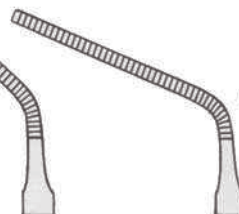

**13.487.13**  
 Fig. 3  
 13,0 cm

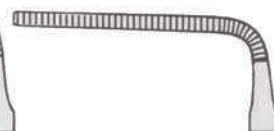

**13.489.13**  
 Fig. 4  
 13,0 cm



**CASTAÑEDA**  
 12,0 cm



**13.491.15**  
 Fig. 1  
 12,0 cm



**13.493.15**  
 Fig. 2  
 12,0 cm



**13.495.12**  
 Fig. 3  
 12,0 cm



**13.495.15**  
 Fig. 4  
 12,0 cm

Kinder-Gefäßklemmen  
 Pediatric Vascular Clamp  
 Pincas vasculaires pédiatriques  
 Pinzas vasculares pediátricas  
 Pinze vascolari pediatriche

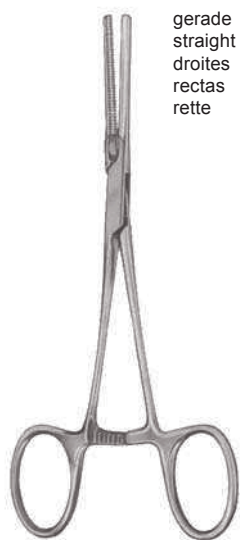

gerade  
 straight  
 droites  
 rectas  
 rette

**13.502.01 - 13.502.09**  
 Fig. 1-9



abgewinkelt  
 angled  
 coudées  
 acodadas  
 angolari

**13.503.01 - 13.503.09**  
 Fig. 1-9



stark abgewinkelt  
 strongly angled  
 fortement coudées  
 fuertemente acodadas  
 fortemente angolari

**13.505.01 - 13.505.09**  
 Fig. 1-9

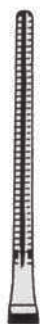

Fig. 1

**13.502.01**  
**13.503.01**  
**13.505.01**



Fig. 2

**13.502.02**  
**13.503.02**  
**13.505.02**



Fig. 3

**13.502.03**  
**13.503.03**  
**13.505.03**

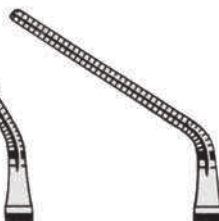

Fig. 4

**13.502.04**  
**13.503.04**  
**13.505.04**



Fig. 5

**13.502.05**  
**13.503.05**  
**13.505.05**



Fig. 6

**13.502.06**  
**13.503.06**  
**13.505.06**

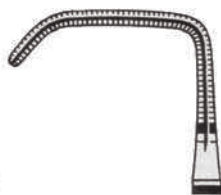

Fig. 7

**13.502.07**  
**13.503.07**  
**13.505.07**



Fig. 8

**13.502.08**  
**13.503.08**  
**13.505.08**



Fig. 9

**13.502.09**  
**13.503.09**  
**13.505.09**

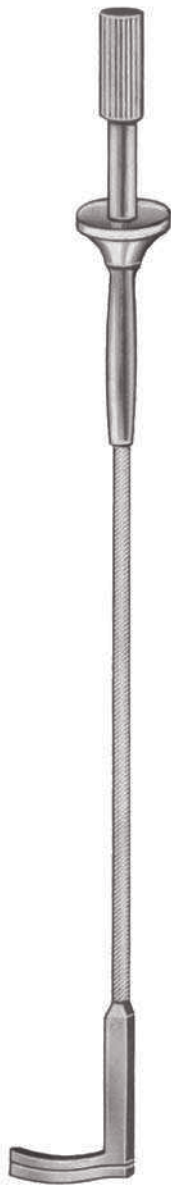

**13.609.12 - 13.611.30**  
20,0 cm



**13.609.12**  
12 mm



**13.609.20**  
20 mm



**13.609.30**  
30 mm

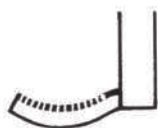

**13.611.12**  
12 mm



**13.611.20**  
20 mm



**13.611.30**  
30 mm

Flexible Gefäßklemmen  
Flexible Vessel Clamps  
Pincas vasculaires flexibles  
Pinzas vasculares flexibles  
Pinze vascolari flessibili

*dimeda*<sup>®</sup>

SURGICAL INSTRUMENTS



**13.615.03**  
ø 3 mm

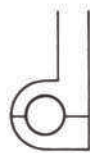

**13.615.05**  
ø 5 mm

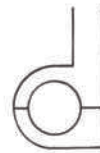

**13.615.07**  
ø 7 mm

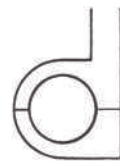

**13.615.09**  
ø 9 mm

**13.615.03 - 13.615.09**

*dimeda*<sup>®</sup>

SURGICAL INSTRUMENTS